

STUD WALL CONDUIT SUPPORTS

BOX MOUNTED CONDUIT/ CABLE SUPPORT

PRODUCT FEATURES

- ▶ Eliminates need for field installed first means of support
- ▶ Attaches directly to any size junction box for a cost-saving solution to first means of support needs
- ▶ Complies with NEC 330.30 (B)
- ▶ Eliminates the need for additional bar hangers in the field
- ▶ BMCS-CJ6 includes a CS-CJ6 for tool-less cable installation

Cat. No.	Description	Std. Pkg.
BMCS	Box Mounted Conduit Cable Support	50
BMCS-CJ6	Box Mounted Conduit Cable Support with CS-CJ6 for tool-less installation	50
CS-CJ6	Stud Mounting Cable Support with locking tab	100

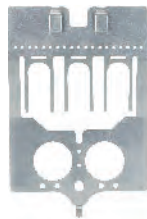

BMCS

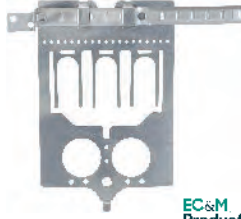

BMCS-CJ6



CS-CJ6



Neat, efficient packaging - prevents individual pieces from linking together



PATENT PENDING

ORBIT INDUSTRIES EXCLUSIVE



TRADITIONAL METHOD

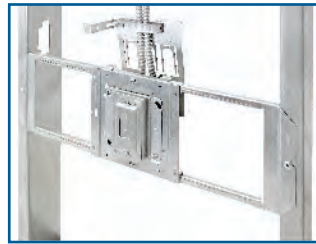

BMCS-CJ6 installed on box helps minimize field work



Installed with just one Wafer Head Screw

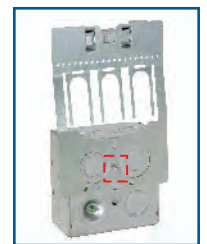

FIRST MEANS OF SUPPORT OPTIONS

CS-CJ6

Secures up to 4 MC/AC Cables without tools

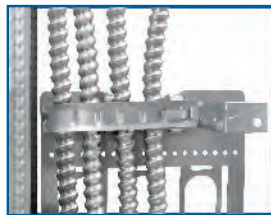

Secures to back of junction box with ONE Wafer Head screw!

Insert tab into lower screw hole on junction box

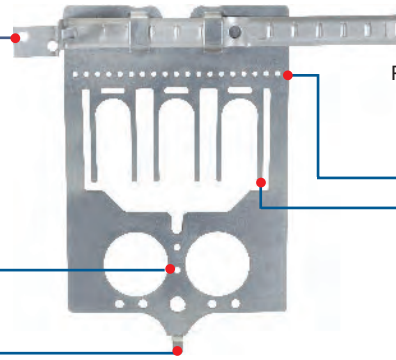

PIN HOLES

Pin holes allow for installation up to 2" straps

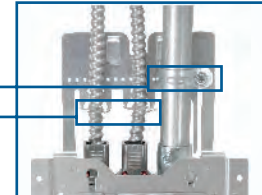

FORKS

Support up to 3 MC/AC Cables without tools

STUD SPANNER RODS WITH CLIPS

PRODUCT FEATURES

- ▶ Supports conduit and MC cable between metal studs - tool-free installation
- ▶ Push-in spring steel clips mount directly to pre-punched holes in metal studs
- ▶ Pre-galvanized steel roll-formed bar securely holds conduit and cables between 16" (SSR-16) and/or 24" (SSR-24) metal studs
- ▶ Accommodates non-standard stud spacing for greater flexibility
- ▶ SSR-C has the versatility to accept 1/4" threaded or plain rod
- ▶ Compatible with Cable/Conduit Clip (CC series) to hold conduit and cable to the bar

Cat. No.	Description	Std. Pkg.
SSR-16 <small>NEW</small>	Stud Spanner Rod with clips, 16" stud spacing	50
SSR-24 <small>NEW</small>	Stud Spanner Rod with clips, 24" stud spacing	50
SSR-C <small>NEW</small>	Clips for Stud Spanner Rod or 1/4" Rod	100

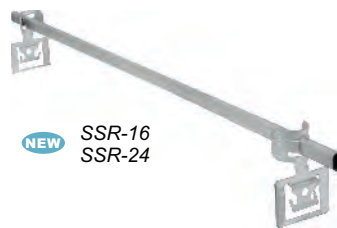

NEW SSR-16
SSR-24



NEW SSR-C



Clips bagged with each bar — no loose parts, no lost clips



SSR-16 attached to metal stud

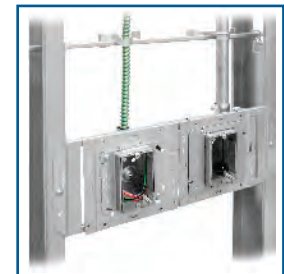

SSR-16 & CC Clips provide MC & Conduit Support

