

SSB SYSTEM

SIMPLE SUPPORT BRACKETS FAMILY

PRODUCT FEATURES

- ▶ **SSB Brackets** rigidity eliminates need for farside back support
- ▶ **SSB Brackets** accept 4", 4-11/16" & 5" Sq. Boxes; must be paired with UMA-LVBS to mount 5" Sq. Boxes
- ▶ **SSB Brackets** expand without removing adapters or junction boxes (ideal for prefabrication)
- ▶ ***SSB-T5** installs between wall studs or overhead between hard lid ceiling joists
- ▶ **SSB-TBAR** includes two riveted clips for T-bar drop ceiling installation
- ▶ Must use **5SLB-2MKO** or **5" Sq. Boxes** with **SSB Brackets** for 1-1/4" or larger conduit
- ▶ **UMA, UMA-LVBS's, UMAB's & UMFAB's** either mount direct-to-stud or clip onto **SSB Brackets**
- ▶ **UMA** compatible with all Orbit Adj. Rings
- ▶ **UMA-LVBS's** compatible with all Orbit Adj. Rings except for *SAR2G models; allows for *AR2G-58 models to mount vertical or horizontal
- ▶ **UMA-LVBS's** allow 4" rings to be mounted independently of boxes, can be used with any size box
- ▶ **UMAB's & UMFAB's** ship with boxes set at 5/8" raise
- ▶ **UMAB's & UMFAB's** are ideal for Life Safety systems rough-in
- ▶ **LVSB1 & LVSB2** eliminate need for an electrical box in low voltage applications on **SSB Brackets**
- ▶ See pg. 2 – 8 for more **SSB System Product Features**

NOTE

- ▶ **SSB Brackets** must be accompanied with either **UMA** or **UMA-LVBS's** to mount a junction box. **UMAB's & UMFAB's** also snap onto **SSB Brackets**.
- ▶ Made in USA SSB-T5 available upon request

Cat. No.	Description	Std. Pkg.
SSB-914-T5 NEW	Simple Support Bracket adjusts from 9" to 14" for mounting 4", 4-11/16" & 5" Sq. boxes between studs	25
*SSB-T5	Simple Support Bracket adjusts from 15" to 25" for mounting 4", 4-11/16" & 5" Sq. boxes between studs, BABA Compliant available upon request	25
SSB-TBAR	SSB-T5 with T-bar Drop Ceiling Mounting Clips, adjusts from 15" to 25"	20
UMA	Universal Mounting Adapter for 4" and 4-11/16" Sq. boxes & multigang boxes to mount to SSB-T5, SSB-TBAR, USB and directly to stud. Break in half to mount multigang boxes	25
UMA-LVBS	Universal Mounting Adapter w/ Back Support (up to 6"), allows for 4", 4-11/16" & 5" Sq. boxes to mount to SSB-T5, SSB-TBAR and directly to stud	25
*US-UMA-LVBS NEW	Made in USA UMA-LVBS, BABA Compliant	25
LVBS-STAND NEW	Snap-on stand for UMA-LVBS, 18" box center, tool-less	10
UMFAB NEW	Front Adjustment 4" Square, 3-1/2" Deep Box, 46 Cu. In., Adj. range: 1/2" to 1-1/2"	10
FA-UMFAB NEW	Front Adjustment Red 4" Square, 3-1/2" Deep Box, 46 Cu. In., Adj. range: 1/2" to 1-1/2"	10
UMAB	External Adjustment 4" Square, 3-1/2" Deep Box, 46 Cu. In., Adj. range: 0" to 1-1/2"	10
FA-UMAB	External Adjustment Red 4" Square, 3-1/2" Deep Box, 46 Cu. In., Adj. range: 0" to 1-1/2"	10
UMAB-4R	External Adjustment 4" (40), 2-1/8" Deep Box w/ 10" PT, 21.1 Cu. In., Adj. range: 0" to 1-1/2"	20
FA-UMAB-4R	External Adjustment Red 4" (40), 2-1/8" Deep Box, 21.1 Cu. In., Adj. range: 0" to 1-1/2"	20
*LVSB1	Low Voltage Stud Mounting Bracket 1-Gang, 1/2" raise, Mounts directly to stud or snaps onto SSB-T5 or SSB-TBAR	50
*LVSB2	Low Voltage Stud Mounting Bracket 2-Gang, 1/2" raise, Mounts directly to stud or snaps onto SSB-T5 or SSB-TBAR	25

**LVSB1 & LVSB2 Spec updated Jan. 2025*

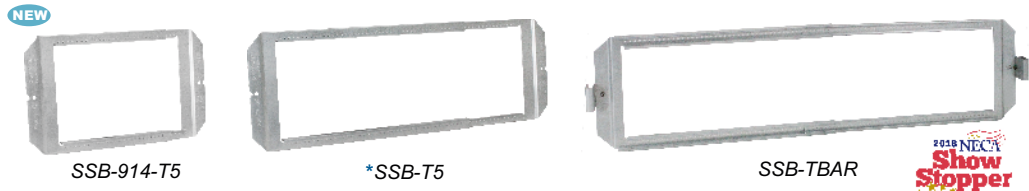

Break in half to mount Multigang Boxes

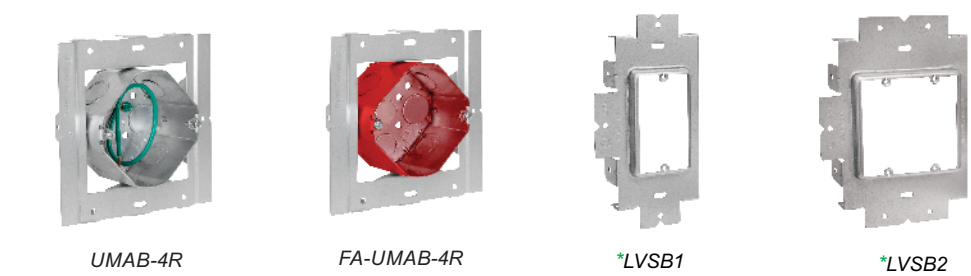
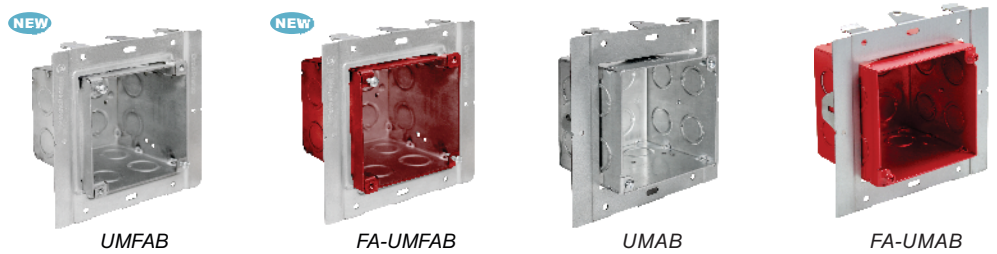
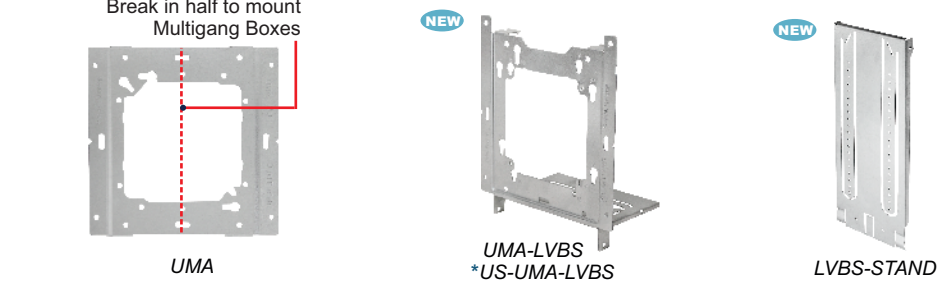

PATENTED ORBIT INDUSTRIES EXCLUSIVE

Video Available On Our Website!



SSB WITH PREASSEMBLED ADJUSTABLE MASON BOX 3-1/2" DEEP

PRODUCT FEATURES

- ▶ **SSB Bracket** adjusts from 15" to 25", rigidity eliminates need for farside back support
- ▶ Ships preassembled with box depth set at 5/8", and adjustable up to 1-1/2"
- ▶ Guided-slots on each side allow the box depth to be easily adjusted by simply loosening the screws
- ▶ Built-In Adapter allows Masonry Box to be moved along SSB Bracket until set in final position with a Tek screw
- ▶ All Knockouts are Concentric 1/2" & 3/4"

Cat. No.	No. of Gangs	KO Ends	KO Bottom	KO Sides	Cu. Inches	Std. Pkg.
SSB-MB3	3	(6) - CKO	(3) - CKO	(4) - CKO	69.3	10
SSB-MB4	4	(8) - CKO	(4) - CKO	(4) - CKO	92.1	10
SSB-MB5	5	(10) - CKO	(5) - CKO	(4) - CKO	116.1	10
SSB-MB6	6	(12) - CKO	(6) - CKO	(4) - CKO	139	10

PATENTED



SSB-MB3



6-way Adjustability



Ex.: Nurse Call Systems
An ideal solution in Nurse Call systems and Headwall assemblies for healthcare projects.

SSB-MB3 SIDE VIEW



Adjustment Screws & Guided Slots
Adjustable 5/8" to 1-1/2"

BOX MOUNTED CONDUIT/ CABLE SUPPORT

PRODUCT FEATURES

- ▶ Eliminates need for field installed first means of support
- ▶ Attaches directly to any size junction box for a cost-saving solution to first means of support needs
- ▶ Complies with NEC 330.30 (B)
- ▶ Eliminates the need for additional bar hangers in the field
- ▶ BMCS-CJ6 includes a CS-CJ6 for tool-less cable installation

Cat. No.	Description	Std. Pkg.
BMCS	Box Mounted Conduit Cable Support	50
BMCS-CJ6	Box Mounted Conduit Cable Support with CS-CJ6 for tool-less installation	50
CS-CJ6	Stud Mounting Cable Support with locking tab	100



BMCS

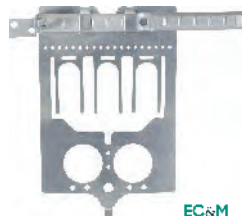

BMCS-CJ6



CS-CJ6



Neat, efficient packaging - prevents individual pieces from linking together

PATENT PENDING

ORBIT INDUSTRIES EXCLUSIVE



TRADITIONAL METHOD

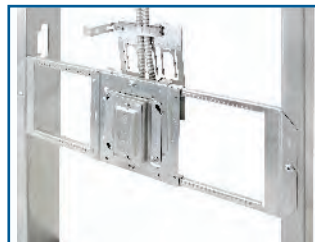

BMCS-CJ6 installed on box helps minimize field work



Installed with just one Wafer Head Screw

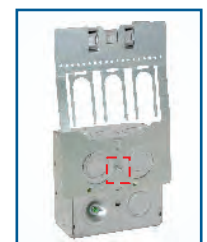

FIRST MEANS OF SUPPORT OPTIONS

CS-CJ6

Secures up to 4 MC/AC Cables without tools



Secures to back of junction box with ONE Wafer Head screw!

Insert tab into lower screw hole on junction box

PIN HOLES

Pin holes allow for installation up to 2" straps

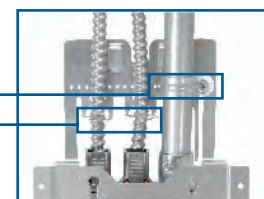

FORKS

Support up to 3 MC/AC Cables without tools



SSB SYSTEM

DIRECT-TO-STUD

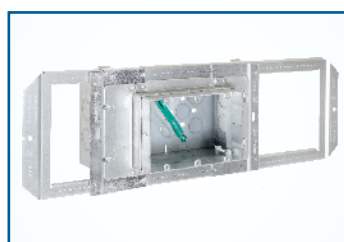
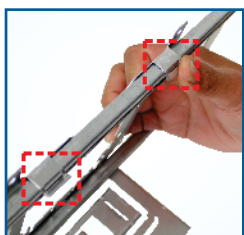
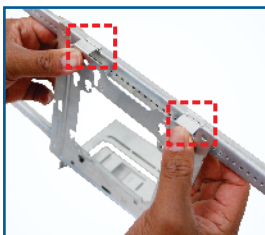
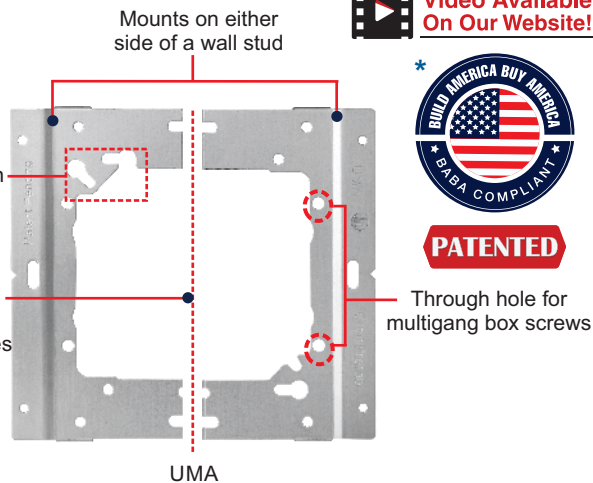
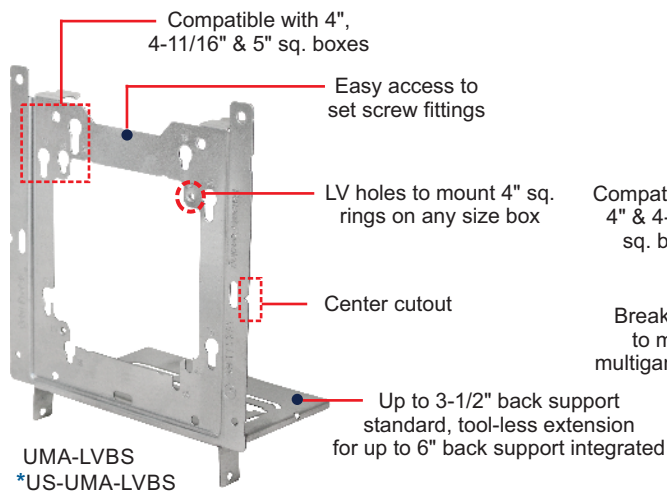

Fold tab to secure adapter on SSB Brackets

Break UMA in half to mount Multigang Boxes

BETWEEN STUDS

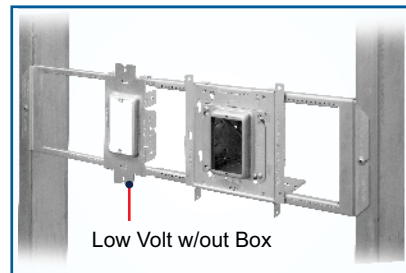
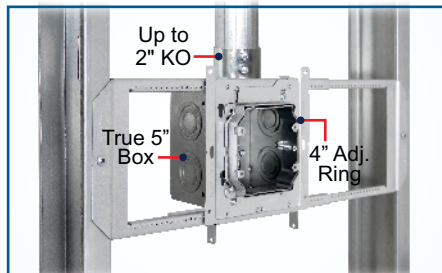
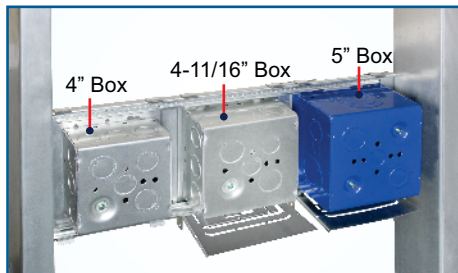
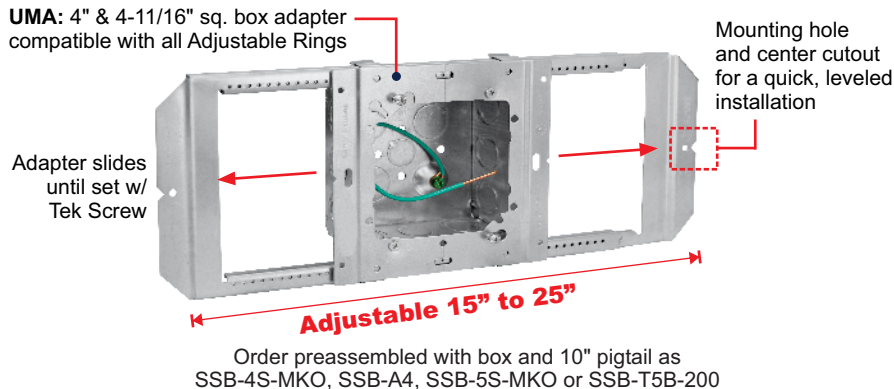
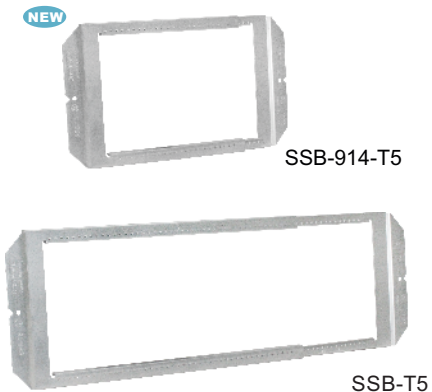

ANY SIZE J-BOX

SSB-T5 fits up to three 4", 4-11/16" or 5" boxes between 24" studs

SSB-T5 INSTALLED

Use 5SLB-2MKO or T5B's for 1-1/4" or larger conduit

NEW POWER + DATA

Use LVSB1 or LVSB2 for Low Voltage applications that do not require a junction box

UMA-LVBS FEATURES

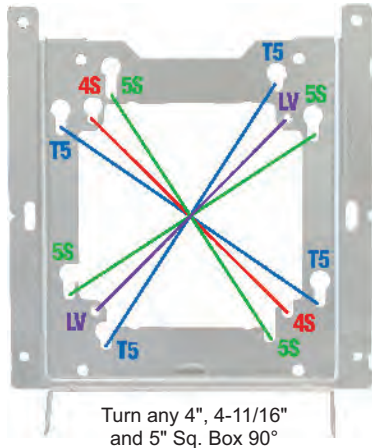

Turn any 4", 4-11/16" and 5" Sq. Box 90°

▶ LV= 4" ring ▶ 4S= 4" sq. ▶ 5S= 4-11/16" sq. ▶ T5= 5" sq.

BUILT-IN BACK SUPPORT & EXTENSION

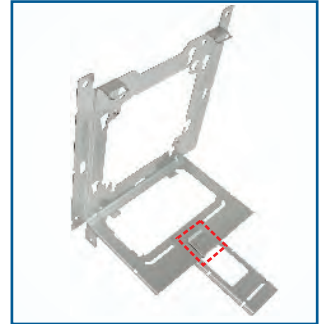
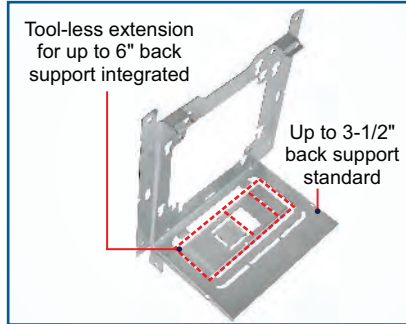

SNAP-OFF

TOOL-LESS INSTALLATION

BOX & RING COMPATIBILITY

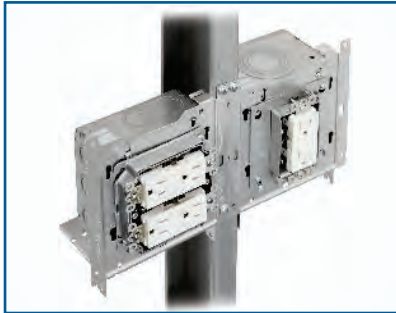

Pair 4" rings with any 4-11/16" or 5" sq. box with UMA-LVBS

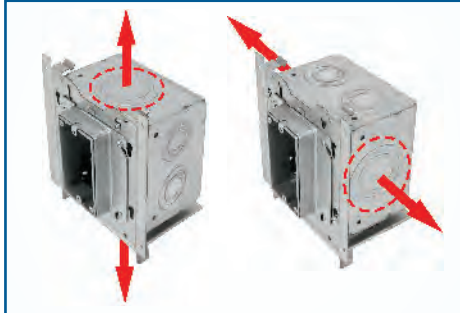

Turn any 4", 4-11/16" and 5" sq. box 90° with UMA-LVBS

FLOOR BRACKET

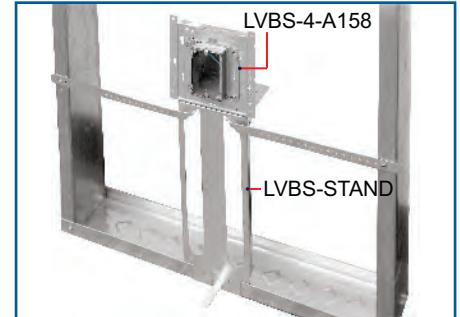

NEW FLOOR BRACKET

Convert any UMA-LVBS assembly to a Floor Bracket with LVBS-STAND. Sets box center at 18".

90° ROTATION



Extended Mounting Tab enables secure mounting with 90° rotation
Box will be able to receive large conduit without removal of back support

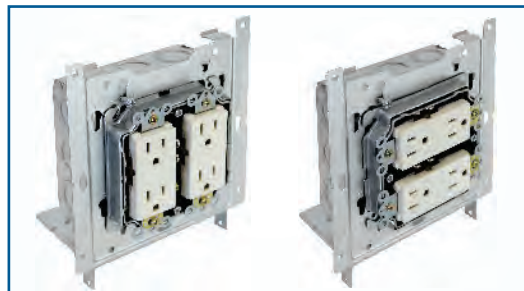

All *AR1G- & *AR2G- rings install vertical or horizontal

STUD MOUNT

VERTICAL & HORIZONTAL RING INSTALLATION

SSB SYSTEM

READY TO INSTALL



UMFAB FEATURES

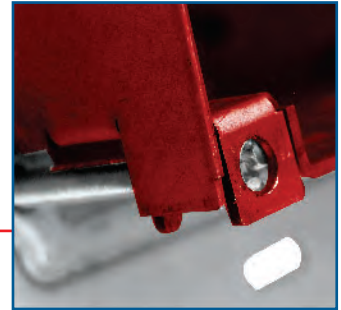

FRONT ADJUSTMENT

Front-mounted screws adjust box depth without interfering with internal wiring

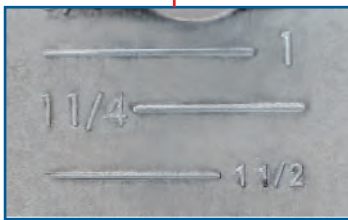
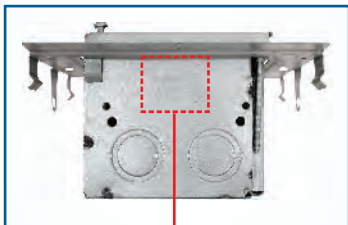

DEPTH MARKING

Engraved depth stamp on box allows for depth measurement without requiring additional measuring tools

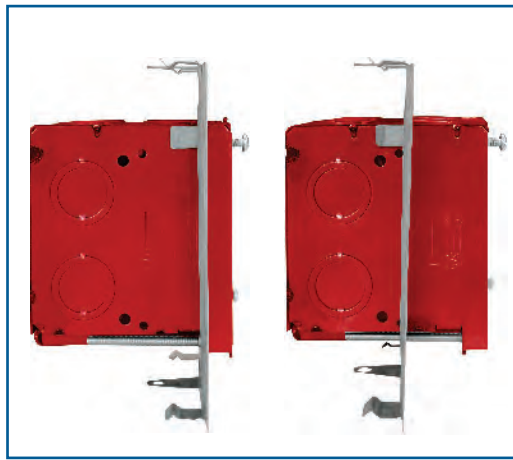

ADJUSTABILITY RANGE

1/2" to 1-1/2"

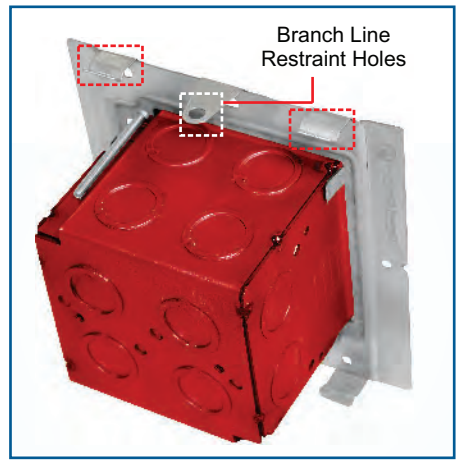

ADAPTER TO BRACKET LATCH

Fold tabs to secure adapter on SSB Brackets

DIRECT-TO, BETWEEN STUDS & OVERHEAD APPLICATIONS

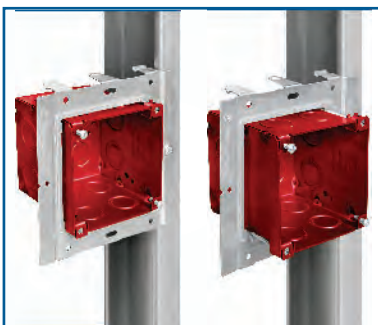

DIRECT TO STUD



BETWEEN STUDS

FA-UMFAB Installed on SSB-T5

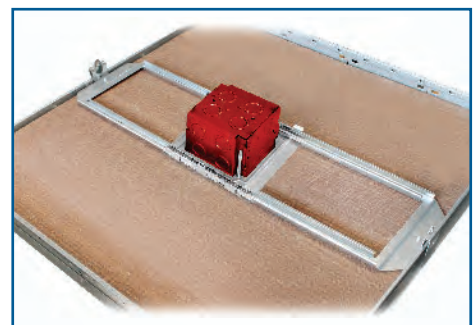

DROP CEILING APPLICATION

FA-UMFAB Installed on SSB-TBAR

DIRECT-TO OR BETWEEN STUDS

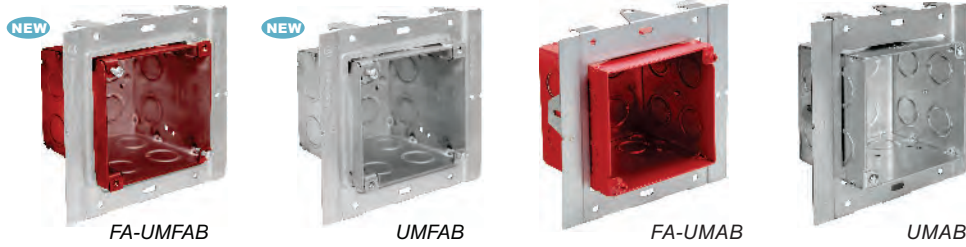

PATENTED



Video Available On Our Website!

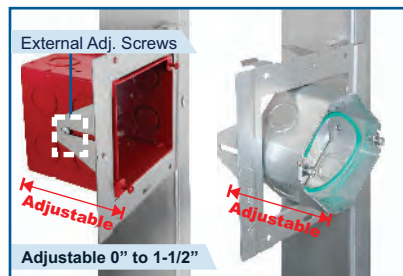

DIRECT-TO-STUD

Guided slots on each side allow the box to be easily adjusted by external screws

BETWEEN STUDS

FA-SSB-UMAB Installed Between Studs

ON HARD LID

FA-SSB-4R Installed in Hard Lid Ceiling Joist

DROP CEILING APPLICATIONS

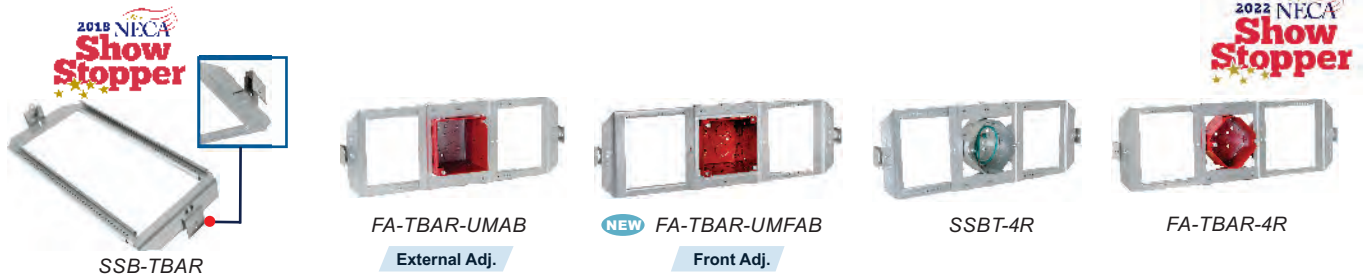

Includes clips for between T-bar drop ceiling grids

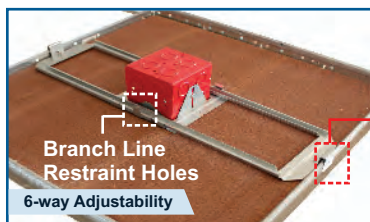

FIRE ALARM ON T-BAR

FA-TBAR-UMAB Installed in Drop Ceiling Grid

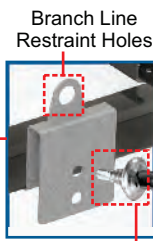

Tek screw provisions on each clip comply with NEC 314.23 (D) (1)

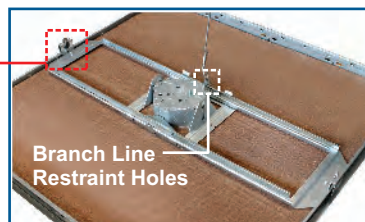

SSBT-4R & FA-TBAR-4R ON T-BAR

Shown Installed in Drop Ceiling w/ Branch Line Restraint

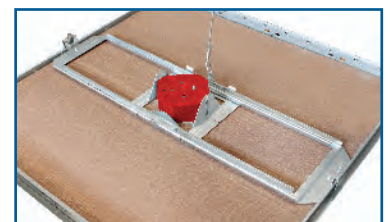

READY-TO-INSTALL ASSEMBLIES

IN-STOCK, PRE-ASSEMBLED ROUGH-IN PRODUCTS

DIRECT-TO-STUD ELECTRICAL ASSEMBLIES

PRODUCT FEATURES

- ▶ Mounts direct-to-stud, or snaps onto the SSB-T5 for stud-to-stud mounting
- ▶ Centerline cutouts and mounting holes on UMA-LVBS's flanges allow for a quick installation onto wood or metal studs
- ▶ Top notch provides easy access to set screw fittings
- ▶ Includes far-side back support for up to 6" deep studs
- ▶ Box includes 10-32 Ground Screw and 10" Solid Cu. #12AWG Pigtail
- ▶ LVBS-A4 Series features MC clamp screws set at 15° angle, includes BMCS-CJ6 cable support

Cat. No.	Components Included				Std. Pkg.
	Bracket	Box	Ring Detail	MC/AC Cable Support	
LVBS-4	UMA-LVBS	4SDB-MKO-PT-10	-	-	25
LVBS-4-158	UMA-LVBS	4SDB-MKO-PT-10	1-G, 5/8" Raise	-	25
LVBS-4-175	UMA-LVBS	4SDB-MKO-PT-10	1-G, 3/4" Raise	-	25
LVBS-4-258	UMA-LVBS	4SDB-MKO-PT-10	2-G, 5/8" Raise	-	25
LVBS-4-275	UMA-LVBS	4SDB-MKO-PT-10	2-G, 3/4" Raise	-	25
LVBS-4-A158	UMA-LVBS	4SDB-MKO-PT-10	1-G, 5/8" - 1-1/4" Raise	-	25
LVBS-4-A134	UMA-LVBS	4SDB-MKO-PT-10	1-G, 3/4" - 1-1/2" Raise	-	25
LVBS-4-A258	UMA-LVBS	4SDB-MKO-PT-10	2-G, 5/8" - 1-1/2" Raise	-	25
LVBS-A4-CS6	UMA-LVBS	4ASDB-AMC-PT	-	BMCS-CJ6	25
LVBS-A4-A158-CS6	UMA-LVBS	4ASDB-AMC-PT	1-G, 5/8" - 1-1/4" Raise	BMCS-CJ6	25

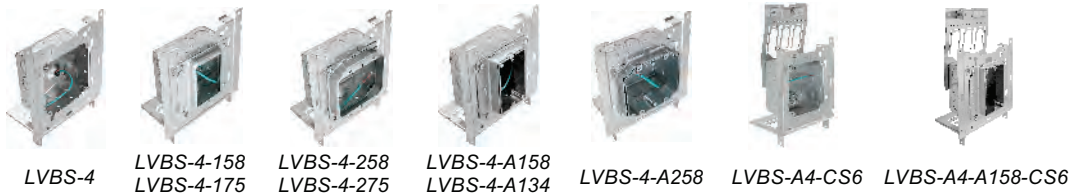

EC&M
Product of the Year
2022 Category #1 (Minors)

DIRECT-TO-STUD LIFE SAFETY ASSEMBLIES

PRODUCT FEATURES

- ▶ Mounts direct-to-stud or to SSB brackets for between-stud or drop ceiling installs
- ▶ Ship with boxes set at 5/8" raise
- ▶ Ideal for Life Safety systems rough-in
- ▶ **UMFAB's:** Front adjustment screws
- ▶ **UMAB's:** External adjustment screws

Cat. No.	Description	Std. Pkg.
UMFAB <small>NEW</small>	Front Adjustment 4" Square, 3-1/2" Deep Box, 46 Cu. In., Adj. range: 1/2" to 1-1/2"	10
FA-UMFAB <small>NEW</small>	Front Adjustment Red 4" Square, 3-1/2" Deep Box, 46 Cu. In., Adj. range: 1/2" to 1-1/2"	10
UMAB	External Adjustment 4" Square, 3-1/2" Deep Box, 46 Cu. In., Adj. range: 0" to 1-1/2"	10
FA-UMAB	External Adjustment Red 4" Square, 3-1/2" Deep Box, 46 Cu. In., Adj. range: 0" to 1-1/2"	10
UMAB-4R	External Adjustment 4" (40), 2-1/8" Deep Box w/ 10" PT, 21.1 Cu. In., Adj. range: 0" to 1-1/2"	20
FA-UMAB-4R	External Adjustment Red 4" (40), 2-1/8" Deep Box, 21.1 Cu. In., Adj. range: 0" to 1-1/2"	20

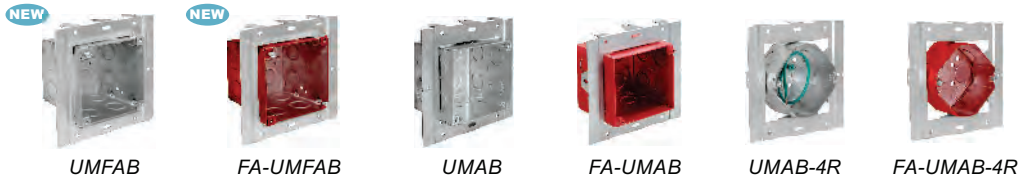

BETWEEN-STUD BOX ASSEMBLIES

PRODUCT FEATURES

- ▶ SSB Brackets rigidity eliminates need for farside back support
- ▶ SSB Brackets expand without removing adapters or junction boxes (ideal for prefabrication)
- ▶ Adjustable SSB bracket fits 15"-25" stud spacing SSB-T5 installs between wall studs or overhead between hard lid ceiling joists
- ▶ Includes 10-32 Ground Screw with 10" Solid Cu. #12AWG Pigtail (except SSB-T5B-200)
- ▶ Box slides along bracket for positioning, then locks with a Tek screw
- ▶ SSB-T5B-200 includes preinstalled #8-32 screws for quick attachment of 4" rings or covers

Cat. No.	Components Included			Std. Pkg.
	Bracket	Adapter	Box	
SSB-4S-MKO	SSB-T5	UMA	4SDB-MKO-PT-10	12
SSB-A4	SSB-T5	UMA	4SDB-AMC-PT	12
SSB-5S-MKO	SSB-T5	UMA	5SDB-MKO-PT-10	12
SSB-T5B-200	SSB-T5	UMA-LVBS	T5B-200	10



EC&M
Product of the Year
2022 Category #1 (Minors)

READY-TO-INSTALL ASSEMBLIES & LOAD CENTER BRACKET

IN-STOCK, PRE-ASSEMBLED ROUGH-IN PRODUCTS

BETWEEN-STUD & OVERHEAD LIFE SAFETY ASSEMBLIES

PRODUCT FEATURES

- ▶ SSB-T5 brackets adjust 15"-25" for between-stud or overhead (hard lid ceiling) applications
- ▶ Box slides along bracket for positioning, then locks with a Tek screw
- ▶ **UMFAB's**: Front adjustment screws
- ▶ **UMAB's**: External adjustment screws

Cat. No.	Components Included			Std. Pkg.
	Bracket	Box/ Adapter	Box Adj. Range	
FA-SSB-UMFAB <small>NEW</small>	SSB-T5	FA-UMFAB	1/2" - 1-1/2"	10
FA-SSB-UMAB	SSB-T5	FA-UMAB	0" - 1-1/2"	10
FA-SSB-4R	SSB-T5	FA-UMAB-4R	0" - 1-1/2"	20

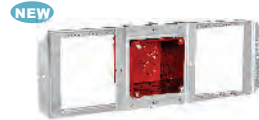

FA-SSB-UMFAB



FA-SSB-UMAB



FA-SSB-4R

DROP-CEILING LIFE SAFETY ASSEMBLIES

PRODUCT FEATURES

- ▶ SSB-TBAR includes clips for T-bar drop ceiling installation
- ▶ Box slides along bracket for positioning, then locks with a Tek screw
- ▶ **UMFAB's**: Front adjustment screws
- ▶ **UMAB's**: External adjustment screws
- ▶ **SSBT-4R** includes 10-32 Ground Screw with 10" Solid Cu. #12AWG Pigtail

Cat. No.	Components Included			Std. Pkg.
	Bracket	Box/ Adapter	Box Adj. Range	
FA-TBAR-UMFAB <small>NEW</small>	SSB-TBAR	FA-UMFAB	1/2" - 1-1/2"	10
FA-TBAR-UMAB	SSB-TBAR	FA-UMAB	0" - 1-1/2"	10
FA-TBAR-4R	SSB-TBAR	FA-UMAB-4R	0" - 1-1/2"	20
SSBT-4R	SSB-TBAR	UMAB-4R	0" - 1-1/2"	20



FA-TBAR-UMFAB



FA-TBAR-UMAB



FA-TBAR-4R

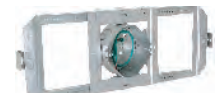

SSBT-4R



LOAD CENTER BRACKET FOR 16" STUD BAYS

PRODUCT FEATURES

- ▶ Attaches to Load Center panels for efficient installation in 16" stud bays
- ▶ Provides positive attachment to stud face
- ▶ Two-piece design ensures easy handling and installation
- ▶ Vertical Slots support MC/AC or Flex cable
- ▶ Use in conjunction with MSC fastener to secure 14-2 thru 12-3 MC/AC cable without tools
- ▶ Ideal for prefabrication of Load Centers
- ▶ Use two Pop Rivets (not included) to attach LCB-16 to Load Center at each corner

NOTE

- ▶ DO NOT drive Tek screws into load center

Cat. No.	Description	Std. Pkg.
LCB-16	Load Center Bracket w/ Vertical Slots for 16" Studs	10



LCB-16



VERTICAL CABLE SLOTS

Support MC/AC and Flex cable tool-free with MSC fastener (sold separately)



IDEAL FOR PREFAB

Bracket designed to travel with Load Centers and cable whips for quick installation on job sites

