

Orbit Industries stocks a huge inventory of Emergency Lights and Exits on both coasts. Orbit LED Exit Signs range from economy-grade plastic signs to spec grade aluminum and edge-lit designs. Emergency Lights range from lightweight models to high-power PAR-style battery units. Available for most applications including multi-family, commercial, light industrial, and outdoor wet locations. All models are UL924 Listed for damp or wet locations. Battery diagnostic switches make these units easy to test per NFPA 101 requirements.

EL2SML | Pg. J2



SUPER MICRO

The EL2SML is one of the most compact commercial LED Emergency Lights on the market. Measuring 7.86", it is roughly half the width of standard emergency light.

Two LED lamps can be hand-adjusted in a full range of motion. Suitable for wall or ceiling mounting. An additional lighting head can be powered by the EL2SML when Remote Capable (RC) battery option is specified. Available in white or black thermoplastic housing.

The EL1DOL is a General Purpose Outdoor LED Light and Emergency Light in one unit. Its low profile die-cast aluminum housing makes it a stylish replacement for security wallpacks. The EL1DOL is UL Wet Location listed. It produces 1,286 lumen output in AC mode; 350 lumen output in emergency mode. Dusk-to-dawn Photocell included.

Available in White, Bronze, Black and Nickel housing finish. Optional Battery Heater also available.

EL1DOL | Pg. J3



SHINE BRIGHT EVEN IN WET LOCATIONS

EST | Pg. J7



**INCREDIBLY THIN,
ONLY 0.86" WIDE**

The EST is one of the slimmest LED Exit Signs on the market. Measuring 0.86" deep, the EST is roughly half the depth of standard exit signs. Despite its size, the EST meets all the same requirements and listings as standard models. Its low profile and elegant lines complement upscale interior decor.

Includes two 'EXIT' faceplates for single or double-face application. A canopy is also included for ceiling or end mounting. Available in Red or Green LED and White or Black plastic housing finish.

The EESL2L satisfies outdoor exit sign and emergency lighting requirements with one unit. An impact-resistant polycarbonate shield protects the exit sign's face(s). A gasket around the lens creates a watertight seal, protecting electronics from corrosion. Two adjustable LED lamp heads provide optimal center-to-center spacing.

White housing, extra Faceplate included for field conversion to Double-Face. Options include Self Diagnostic Testing, Remote Capable battery, and Internal Battery Heater for cold weather.

EESL2L | Pg. J15



**MICRO WET LOCATION
COMBO UNIT**



EL2HM-LED-W



EL2NM-LED-W



EL2SML-W



EL2FM-LED-W



EL2TLM-W **NEW**



EL1DOL-BR



EL2LR-W



EL2T6/EL2T12



EL2H-WP-GY



EL2H-WP-LED-GY



EL2TN4



EL2TN4-LED-GY



EST-W-G



ESBLM-W-R



ESBL-W-R



ESL-W-R



ESLA-B-A-1-G



ESLAM-B-A-1-G



ESI-G/ESI-R



ESN-B-G-1



ESSE-A-2-R



ESRE-A-2-G



EECLM-LED-W-R



EECMPL-W-R



EECLMS-W-G



EECLP-LED-W-1-R



EESLA-LED-A-A-1-G



EECLA-W-G



ESLN4M-W-1-G



EESL2L-1-R **NEW**



ESB2L-GY-1-R



LRHS-1



LRHS-2



LRHR-1 **NEW**



LRHR-2 **NEW**



LRHS-WP-1



LRHS-WP-2



PCS-R



PCS-D



WG-15



WG-30



REPLACEMENT BATTERIES



LRK-SI

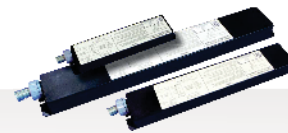

LBAL SERIES



EALBS



CLCSL

Exit & Emergency

EL2HM-LED

MICRO ADJUSTABLE ROUND HEAD
LED EMERGENCY LIGHT

PRODUCT FEATURES

- ▶ Dual-Voltage Input 120/277VAC Operation
- ▶ UL Listed for Damp Location
- ▶ Long-lasting, Energy Saving ultra-bright LED Lamps (0.65W per lamp head)
- ▶ 90 Minutes Minimum Emergency Operation
- ▶ Injection Molded, 5VA Flame Retardant, High Impact, Thermoplastic
- ▶ Fully adjustable, glare-free Lamp Heads
- ▶ Universal Mounting Pattern with 1/2" Knockout
- ▶ Suitable for wall and ceiling mounting
- ▶ High Performance Chrome Plated Reflector
- ▶ Push-to-Test Switch
- ▶ Maintenance-free 3.6V NiCd Battery
- ▶ Fully automatic operation



EL2HM-LED-W

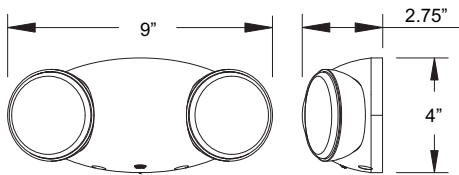

Cat. No.	Housing Color	Options
EL2HM-LED	W (White) B (Black)	HO (High Output)

EL2NM-LED

MICRO ADJUSTABLE SQUARE HEAD
LED EMERGENCY LIGHT

PRODUCT FEATURES

- ▶ Dual-Voltage Input 120/277VAC Operation
- ▶ UL Listed for Damp Location
- ▶ Long-lasting, Energy Saving ultra-bright LED Lamps (1W per lamp head)
- ▶ 90 Minutes Minimum Emergency Operation
- ▶ Injection Molded, 5VA Flame Retardant, High Impact, Thermoplastic
- ▶ Fully adjustable, glare-free Lamp Heads
- ▶ Universal Mounting Pattern with Quick-Connect
- ▶ Conduit Mount Knockout on top of housing
- ▶ Suitable for wall and ceiling mounting
- ▶ High Performance Chrome Plated Reflector
- ▶ Push-to-Test Switch
- ▶ Maintenance-free 3.6V NiCd Battery
- ▶ Fully automatic operation
- ▶ Remote Capable for up to 2 additional Lamp Heads (**HO Only**)

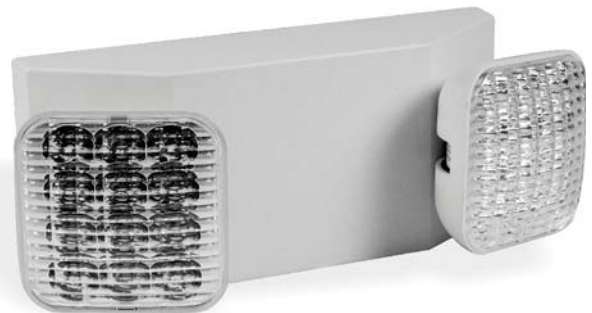

EL2NM-LED-W

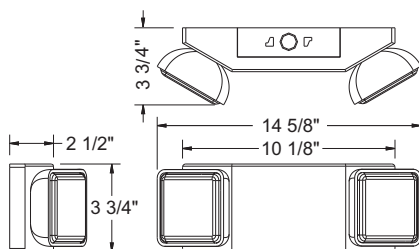

Cat. No.	Housing Color	Options
EL2NM-LED	W (White) B (Black)	HO (High Output) SDT (Self Diagnostic Test)

Exit & Emergency



EL2SML

SUPER MICRO ADJUSTABLE HEAD LED EMERGENCY LIGHT

PRODUCT FEATURES

- ▶ Dual-Voltage Input 120/277VAC Operation
- ▶ UL Listed for Damp Location
- ▶ Long-lasting, Energy Saving ultra-bright LED Lamps (0.5W per lamp head)
- ▶ 90 Minutes Minimum Emergency Operation
- ▶ Injection Molded, 5VA Flame Retardant, High Impact, Thermoplastic
- ▶ Fully adjustable, glare-free Lamp Heads
- ▶ Universal Mounting Pattern with Quick-Connect
- ▶ Suitable for wall and ceiling mounting
- ▶ Push-to-Test Switch
- ▶ LED indicator light alerts occupant of battery level
- ▶ Maintenance-free 3.6V NiCd Battery
- ▶ Fully automatic operation

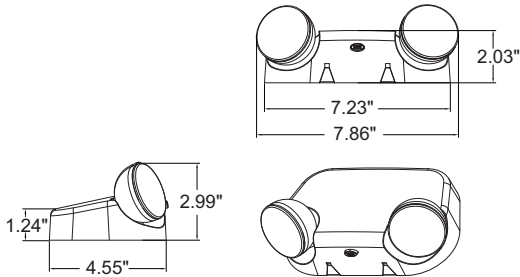

NEW



EL2SML-W

Cat. No.	Housing Color	Options
EL2SML	W (White) B (Black)	RC (Remote Capacity)



EL2FM-LED

MICRO ADJUSTABLE LED EMERGENCY LIGHT

PRODUCT FEATURES

- ▶ Dual-Voltage Input 120/277VAC Operation
- ▶ UL Listed for Damp Location
- ▶ Long-lasting, Energy Saving ultra-bright LED Lamps (1W per lamp head)
- ▶ 90 Minutes Minimum Emergency Operation
- ▶ Injection Molded, 5VA Flame Retardant, High Impact, Thermoplastic
- ▶ Fully adjustable, glare-free Lamp Heads
- ▶ Universal Mounting Pattern with Quick Connect
- ▶ Conduit Mount Knockout on top of housing
- ▶ Suitable for wall and ceiling mounting
- ▶ Push-to-Test Switch
- ▶ Maintenance-free 3.6V NiCd Battery
- ▶ Fully automatic operation

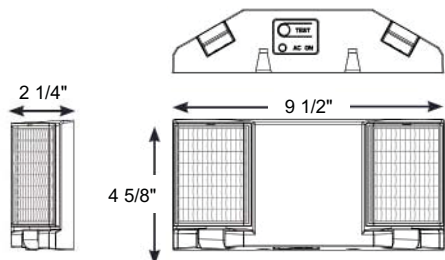

EL2FM-LED-W

Cat. No.	Housing Color
EL2FM-LED	W (White) B (Black)



EL2TLM

THIN ADJUSTABLE ROUND HEAD
HIGH OUTPUT LED EMERGENCY LIGHT

PRODUCT FEATURES

- ▶ Universal-Voltage Input 100 ~ 300VAC Operation
- ▶ UL Listed for Damp Location
- ▶ Long-lasting, Energy Saving ultra-bright LED Lamps (2W per lamp head)
- ▶ 90 Minutes Minimum Emergency Operation
- ▶ Injection Molded, V-O Flame Retardant, High Impact, Thermoplastic
- ▶ Fully adjustable, glare-free Lamp Heads
- ▶ Universal Mounting Plate with 1/2" Knockout
- ▶ Suitable for wall and ceiling mounting
- ▶ Push to Test Switch
- ▶ Maintenance free 3.2V Lithium Ion Battery
- ▶ Fully automatic operation
- ▶ **RC** option offers additional 2.8W for 90 min.

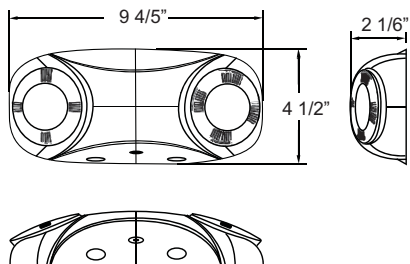

NEW



EL2TLM-W

Cat. No.	Housing Color	Options
EL2TLM	W (White) B (Black)	SDT (Self Diagnostic Test) RC (Remote Capacity)

EL1DOL

DECORATIVE WET LOCATION
LED EMERGENCY LIGHT

PRODUCT FEATURES

- ▶ Universal Voltage 120~277VAC Operation
- ▶ UL Listed for Wet Location
- ▶ Suitable for cold weather with heater option (-10°C - 40°C)
- ▶ 12W, 5000K Energy Saving LED Lamp
- ▶ 1286 lumens standard and 350 lumens in Emergency mode
- ▶ 90 Minutes Minimum Emergency Operation
- ▶ Die Cast Aluminum Housing with Powder Coated Finish
- ▶ Universal Mounting Plate
- ▶ Threaded opening at top of enclosure for Conduit Mounting
- ▶ Suitable for wall and ceiling mounting
- ▶ Can be used as a Normal Light or an Emergency Light
- ▶ **Built-In Photocell**
- ▶ Self Diagnostic Testing Standard
- ▶ Push-to-Test Switch
- ▶ Maintenance-free 4.8V Rechargeable NiCd Battery
- ▶ Fully automatic operation

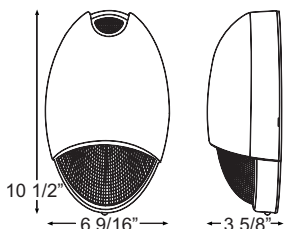

EL1DOL-BR

Exit & Emergency

Cat. No.	Housing Color	Option
EL1DOL	W (White) BR (Bronze) B (Black) N (Nickel)	HTR (Internal Heater)



EL2LR

RECESSED LED EMERGENCY LIGHT

PRODUCT FEATURES

- ▶ Dual-Voltage Input 120/277VAC Operation
- ▶ Two fully adjustable 1W LED Lamp Heads
- ▶ 90 Minutes Minimum Emergency Operation
- ▶ Durable 20 Gauge Steel Trim Plate
- ▶ Adjustable Bar Hanger up to 24" for Recessed Mounting
- ▶ Push-to-Test Switch
- ▶ High capacity battery offers 10W of Remote Capacity
- ▶ Maintenance-free 6V, Rechargeable Sealed Lead-Acid Battery
- ▶ Fully automatic operation

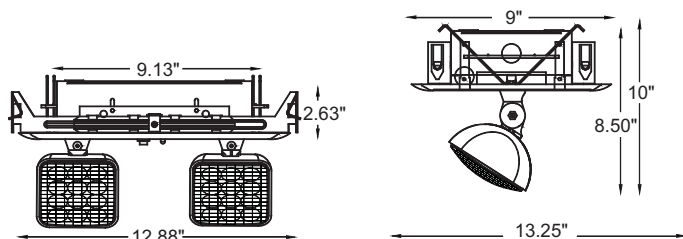

EL2LR-W



Cat. No.	Housing Color
EL2LR	W (White) B (Black)

EL2T6

EL2T12

HIGH OUTPUT EMERGENCY LIGHT

PRODUCT FEATURES

- ▶ Dual-Voltage Input 120/277VAC Operation
- ▶ 90 Minutes Minimum Emergency Operation
- ▶ Injection Molded, 5VA Flame Retardant, High Impact, Thermoplastic Knockout on back of housing for wall mount
- ▶ Push-to-Test Switch
- ▶ Maintenance-free 6V Sealed Lead-Acid Battery
- ▶ Fully automatic operation

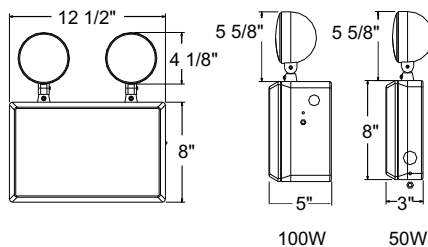

EL2T6/EL2T12



Cat. No.	Voltage	Output	Lamp Wattage
EL2T650	6V	50W	2 x 7.2W
EL2T6100	6V	100W	2 x 7.2W
EL2T1250	12V	50W	2 x 7.2W
EL2T12100	12V	100W	2 x 7.2W

EL2H-WP

ADJUSTABLE WET LOCATION EMERGENCY LIGHT

PRODUCT FEATURES

- ▶ Dual-Voltage Input 120/277VAC Operation
- ▶ UL Listed for Wet Location
- ▶ Two fully adjustable, glare-free 6V, 7W MR16 Halogen Lamps
- ▶ 90 Minutes Minimum Emergency Operation
- ▶ Injection Molded, 5VA Flame Retardant, High Impact, Thermoplastic
- ▶ Universal Mounting Plate
- ▶ Surface wall mount only
- ▶ Push-to-Test Switch
- ▶ Maintenance-free 6V, 4.5AH Sealed Lead-Acid Battery
- ▶ Fully automatic operation



EL2H-WP-GY

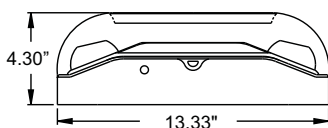
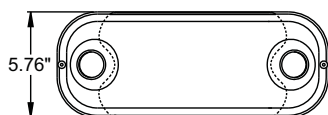

Cat. No.	Housing Color
EL2H-WP	GY (Grey) B (Black)

EL2H-WP-LED

ADJUSTABLE WET LOCATION LED EMERGENCY LIGHT

PRODUCT FEATURES

- ▶ Dual-Voltage Input 120/277VAC Operation
- ▶ UL Listed for Wet Location
- ▶ Long-lasting, Energy Saving ultra-bright LED Lamps (0.6W per lamp head)
- ▶ 90 Minutes Minimum Emergency Operation
- ▶ Injection Molded, 5VA Flame Retardant, High Impact, Thermoplastic
- ▶ Fully adjustable, glare-free Heads
- ▶ Universal Mounting Pattern with 1/2" Knockout in back
- ▶ Surface wall mount only
- ▶ Push-to-Test Switch
- ▶ Maintenance-free 3.6V NiCd Battery
- ▶ Fully automatic operation



EL2H-WP-LED-GY

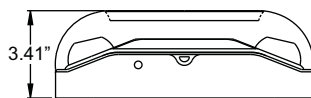
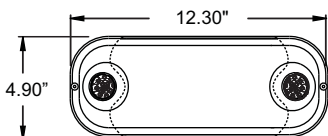

Cat. No.	Housing Color
EL2H-WP-LED	GY (Grey) B (Black)

Exit & Emergency



EL2TN4

REMOTE HEAD WET LOCATION EMERGENCY LIGHT

PRODUCT FEATURES

- ▶ Dual-Voltage Input 120/277VAC Operation
- ▶ UL Listed for Wet Location
- ▶ Suitable for cold weather **with heater option (-10°C - 40°C)**
- ▶ Two fully adjustable 6V 7.2W T5 Wedge Base Waterproof Lamp Heads
- ▶ 90 Minutes Minimum Emergency Operation
- ▶ Injection Molded, 5VA Flame Retardant, High Impact, Thermoplastic
- ▶ Fully Gasketed Corrosion-Resistant Enclosure
- ▶ Surface wall mount only
- ▶ Sealed Push-to-Test Switch
- ▶ White housing only
- ▶ Maintenance-free 6V, 10AH Sealed Lead-Acid Battery
- ▶ Fully automatic operation



EL2TN4

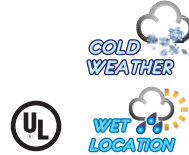
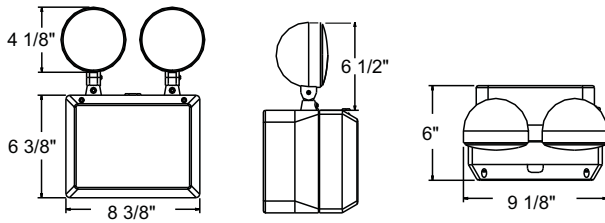

Cat. No.	Options
EL2TN4	HTR (Internal Heater)

EL2TN4-LED

REMOTE HEAD WET LOCATION LED EMERGENCY LIGHT

PRODUCT FEATURES

- ▶ Dual-Voltage Input 120/277VAC Operation
- ▶ UL Listed for Wet Location
- ▶ Suitable for cold weather (-10°C - 40°C)
- ▶ Two fully adjustable ultra-bright LED Lamp Heads (1.5W per lamp head)
- ▶ 90 Minutes Minimum Emergency Operation
- ▶ Injection Molded, 5VA Flame Retardant, High Impact, Thermoplastic
- ▶ Fully Gasketed Corrosion-Resistant Enclosure
- ▶ Surface wall mount only, brackets included
- ▶ Sealed Push-to-Test Switch
- ▶ Maintenance-free 9.6V NiCd Battery
- ▶ Fully automatic operation



EL2TN4-LED-GY

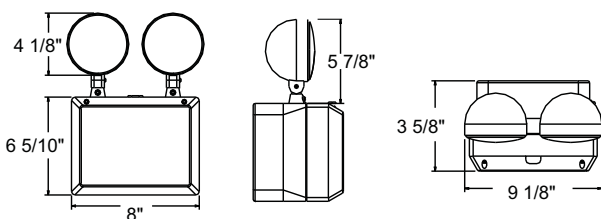

Cat. No.	Housing Color
EL2TN4-LED	GY (Grey) B (Black)

EST

THIN THERMOPLASTIC LED EXIT SIGN

PRODUCT FEATURES

- ▶ Dual-Voltage Input 120/277VAC Operation
- ▶ UL Listed for Damp Location
- ▶ Long-lasting, Energy Saving LED Lamps
- ▶ 90 Minutes Minimum Emergency Operation
- ▶ Injection Molded, 5VA Flame Retardant, High Impact, Thermoplastic
- ▶ Universal Mounting Pattern
- ▶ Canopy for ceiling or end mounting included
- ▶ Easy Snap-out Chevrons Directional Indicators
- ▶ Extra Faceplate included for field conversion to Double-Face
- ▶ Push-to-Test Switch
- ▶ Maintenance-free 1.2V NiCd Battery
- ▶ Fully automatic operation

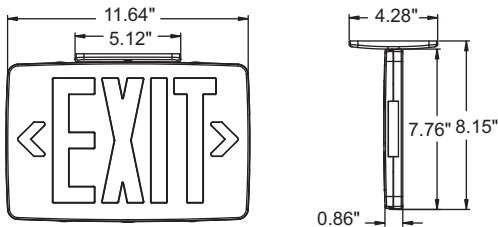

EST-W-G

Cat. No.	Housing Color	Letter Color	Operation
EST	W (White) B (Black)	R (Red) G (Green)	EB (Battery Back-Up) AC (AC Only)

ESBLM

MICRO THERMOPLASTIC LED EXIT SIGN WITH BATTERY BACK-UP

PRODUCT FEATURES

- ▶ Dual-Voltage Input 120/277VAC Operation
- ▶ UL Listed for Damp Location
- ▶ Long-lasting, Energy Saving LED Lamps
- ▶ 90 Minutes Minimum Emergency Operation
- ▶ Injection Molded, 5VA Flame Retardant, High Impact, Thermoplastic
- ▶ Universal Mounting Pattern
- ▶ Canopy for ceiling or end mounting included
- ▶ Easy Snap-out Chevrons Directional Indicators
- ▶ Extra Faceplate included for field conversion to Double-Face
- ▶ Push-to-Test Switch
- ▶ Maintenance-free 2.4V NiCd Battery
- ▶ Fully automatic operation

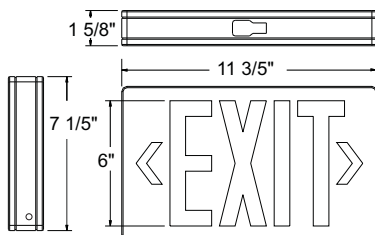

ESBLM-W-R

Cat. No.	Housing Color	Letter Color	Options
ESBLM	W (White) B (Black)	R (Red) G (Green)	RC (Remote Capacity)



ESBL

*THERMOPLASTIC LED EXIT SIGN
WITH BATTERY BACK-UP*

PRODUCT FEATURES

- ▶ Dual-Voltage Input 120/277VAC Operation
- ▶ UL Listed for Damp Location
- ▶ Long-lasting, Energy Saving LED Lamps
- ▶ 90 Minutes Minimum Emergency Operation
- ▶ Injection Molded, 5VA Flame Retardant, High Impact, Thermoplastic
- ▶ Universal Mounting Pattern
- ▶ Canopy for ceiling or end mounting included
- ▶ Easy Snap-out Chevrons Directional Indicators
- ▶ Extra Faceplate included for field conversion to Double-Face
- ▶ Push-to-Test Switch
- ▶ Maintenance-free 4.8V NiCd Battery
- ▶ Fully automatic operation

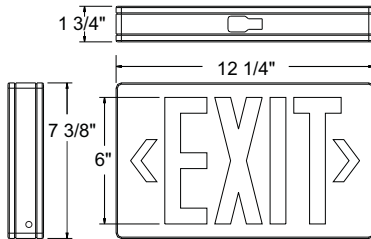

ESBL-W-R



Cat. No.	Housing Color	Letter Color	Options
ESBL	W (White) B (Black)	R (Red) G (Green)	SDT (Self Diagnostic Test) RC (Remote Capable)

ESL

THERMOPLASTIC LED EXIT SIGN

PRODUCT FEATURES

- ▶ Dual-Voltage Input 120/277VAC Operation (Except 2C models)
- ▶ UL Listed for Damp Location
- ▶ Long-lasting, Energy Saving LED Lamps
- ▶ Injection Molded, 5VA Flame Retardant, High Impact, Thermoplastic
- ▶ Universal Mounting Pattern
- ▶ Canopy for ceiling or end mounting included
- ▶ Easy Snap-out Chevrons Directional Indicators
- ▶ Extra Faceplate included for field conversion to Double-Face

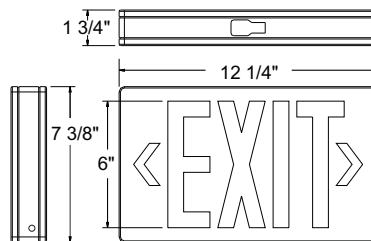

ESL-W-R



Cat. No.	Housing Color	Letter Color	Options
ESL ESL2C (Dual Circuit)	W (White) B (Black)	R (Red) G (Green)	Blank (AC Only) 2C-120 (Dual-Circuit Op., 120V) 2C-277 (Dual-Circuit Op., 277V)

ESLA

CAST ALUMINUM LED EXIT SIGN

PRODUCT FEATURES

- ▶ Dual-Voltage Input 120/277VAC Operation (Except 2C models)
- ▶ UL Listed for Damp Location
- ▶ Long-lasting, Energy Saving LED Lamps
- ▶ 90 Minutes Minimum Emergency Operation (**EB Only**)
- ▶ Premium Grade Aluminum Housing
- ▶ Universal Mounting Pattern
- ▶ Aluminum Canopy for ceiling or end mounting included
- ▶ Knockout Chevrons Directional Indicators
- ▶ Push-to-Test Switch
- ▶ Maintenance-free 4.8V NiCd Battery (**EB Only**)
- ▶ Fully automatic operation (**EB Only**)



ESLA-B-A-1-G

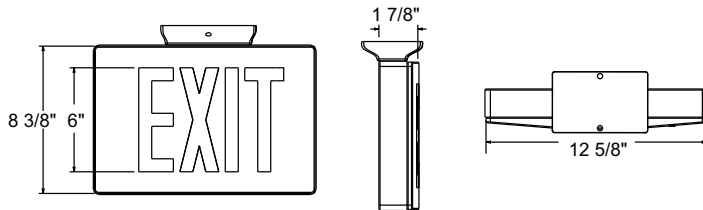

Cat. No.	Housing Color	Faceplate	No. of Faces	Letter Color	Operation	Options
ESLA	A (Aluminum)	A (Aluminum)	1	R (Red)	EB (Battery Back-Up)	SDT (Self Diagnostic Test)
	W (White)	W (White)	2	G (Green)	AC (AC Only)	2C-120 (Dual-Circuit Op., 120V)
	B (Black)	B (Black)			Blank (If 2C)	2C-277 (Dual-Circuit Op., 277V)

ESLAM

MICRO CAST ALUMINUM LED EXIT SIGN

PRODUCT FEATURES

- ▶ Dual-Voltage Input 120/277VAC Operation
- ▶ UL Listed for Damp Location
- ▶ Long-lasting, Energy Saving LED Lamps
- ▶ 90 Minutes Minimum Emergency Operation (**EB Only**)
- ▶ Premium Grade Aluminum Housing
- ▶ Universal Mounting Pattern
- ▶ Aluminum Canopy for ceiling or end mounting included
- ▶ Knockout Chevrons Directional Indicators
- ▶ Push-to-Test Switch
- ▶ Maintenance-free 2.4V NiCd Battery (**EB Only**)
- ▶ Fully automatic operation (**EB Only**)



ESLAM-B-A-G

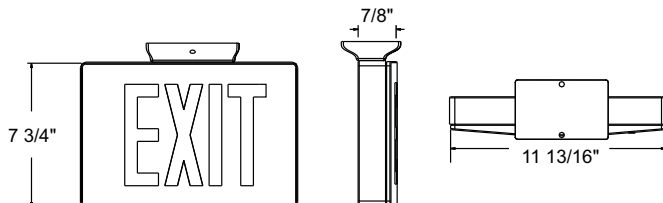

Cat. No.	Housing Color	Faceplate	No. of Faces	Letter Color	Operation
ESLAM	B (Black)	A (Aluminum)	1 (Blank)	R (Red)	EB (Battery Back-Up)
		W (White)	2	G (Green)	AC (AC Only)
		B (Black)			



ESI

SELF-ILLUMINATING LOW-LEVEL EXIT SIGN

PRODUCT FEATURES

- ▶ Non-Electrical, Non-Nuclear
- ▶ Non-Radioactive
- ▶ UL Listed
- ▶ Minimum 5 Foot-Candles (54 Lux) external unfiltered Fluorescent
- ▶ 90 minutes of illumination upon failure of utility power
- ▶ Rated viewing distance of 50 feet
- ▶ Aluminum Body
- ▶ Photoluminescent Surface
- ▶ Built-in wall mount
- ▶ Field Applied Chevrons Included
- ▶ Single face only
- ▶ Indoor use only



(From Top) ESI-G/ESI-R

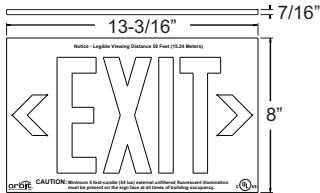

Mounting Bracket Included



Illuminated



Cat. No.	Letter Color
ESI	R (Red) G (Green)

ESN

SELF-ILLUMINATING TRITIUM (NUCLEAR) EXIT SIGN

PRODUCT FEATURES

- ▶ Tritium-Powered Self-Illuminating
- ▶ Non-Electrical, Nuclear
- ▶ UL Listed for Wet Location
- ▶ Non-Radioactive and Non-Explosive
- ▶ 10 Foot candles ambient lighting
- ▶ 90 minutes of illumination upon failure of utility power
- ▶ Rated viewing distance of 100 feet
- ▶ Surface Mount Bracket
- ▶ Letter-shaped light tubes for best lighting
- ▶ Field applied chevrons included



ESN-B-G-1

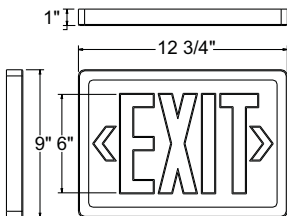

Cat. No.	Housing Color	Faceplate	No. of Faces	Life in Years
ESN	W (White) B (Black)	R (Red) G (Green)	1 2	10 20

ESSE

SURFACE MOUNT EDGE-LIT LED EXIT SIGN

PRODUCT FEATURES

- ▶ Dual-Voltage Input 120/277VAC Operation (Except 2C models)
- ▶ UL Listed for Damp Location
- ▶ Long-lasting, Energy Saving LED Lamps
- ▶ 90 Minutes Minimum Emergency Operation (**EB Only**)
- ▶ Premium Grade Extruded Aluminum Housing
- ▶ Aluminum Canopy for wall, ceiling, or end mounting included
- ▶ Field applied Chevrons Included
- ▶ UV Stabilized ultra clear acrylic Edge Lit Panel
- ▶ Single-Face Panels are **Clear**, Double-Face Panels are **Opaque**
- ▶ Push-to-Test Switch
- ▶ Long life, Maintenance-free 4.8V NiCd Battery (**EB Only**)
- ▶ Fully automatic operation (**EB Only**)

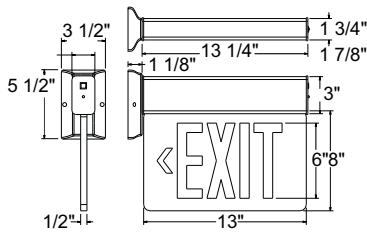

Cat. No.	Casing Color	No. of Faces	Letter Color	Operation	Options
ESSE	A (Aluminum)	1	R (Red)	EB (Battery Back-Up)	SDT (Self Diagnostic Test)
	W (White) B (Black)	2	G (Green)	AC (AC Only)	2C-120 (Dual-Circuit Op., 120V) 2C-277 (Dual-Circuit Op., 277V)



ESSE-A-2-R

ESRE

RECESSED MOUNT EDGE-LIT LED EXIT SIGN

PRODUCT FEATURES

- ▶ Dual-Voltage Input 120/277VAC Operation (Except 2C models)
- ▶ UL Listed for Damp Location
- ▶ Long-lasting, Energy Saving LED Lamps
- ▶ 90 Minutes Minimum Emergency Operation (**EB Only**)
- ▶ Premium Grade Extruded Aluminum Housing
- ▶ Adjustable Bar Hanger up to 24" for Recessed Mount
- ▶ Field applied Chevrons Included
- ▶ UV Stabilized ultra clear acrylic Edge Lit Panel
- ▶ Single-Face Panels are **Clear**, Double-Face Panels are **Opaque**
- ▶ Push-to-Test Switch
- ▶ Maintenance-free 4.8V NiCd Battery (**EB Only**)
- ▶ Fully automatic operation (**EB Only**)

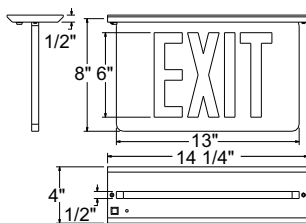

Cat. No.	Casing Color	No. of Faces	Letter Color	Operation	Options
ESRE	A (Aluminum)	1	R (Red)	EB (Battery-Back Up)	SDT (Self Diagnostic Test)
	W (White) B (Black)	2	G (Green)	AC (AC Only)	2C-120 (Dual-Circuit Op., 120V) 2C-277 (Dual-Circuit Op., 277V)



ESRE-A-2-G



EECLM-LED

MICRO LED EMERGENCY LIGHT/EXIT SIGN
COMBO UNIT WITH BATTERY BACK-UP

PRODUCT FEATURES

- ▶ Dual-Voltage Input 120/277VAC Operation
- ▶ UL Listed for Damp Location
- ▶ Long-lasting, Energy Saving LED Lamps
- ▶ 90 Minutes Minimum Emergency Operation
- ▶ Injection-Molded, 5VA Flame Retardant, High Impact, Thermoplastic
- ▶ Round fully adjustable LED Lamp Heads (0.75W per lamp head)
- ▶ Universal Mounting Pattern
- ▶ Canopy for ceiling mounting included
- ▶ Easy Snap-out Chevrons Directional Indicators
- ▶ Extra Faceplate included for field conversion to Double-Face
- ▶ Push to Test Switch
- ▶ Maintenance free 3.6V, NiCd Battery
- ▶ Fully automatic operation

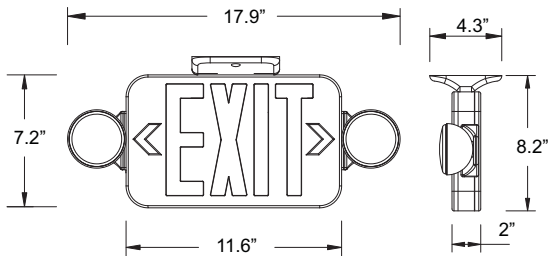

EECLM-LED-W-R

Cat. No.	Housing Color	Letter Color	Options
EECLM	W (White) B (Black)	R (Red) G (Green)	RC (Remote Capacity)

EECMPL

MICRO LED EMERGENCY LIGHT/EXIT SIGN
COMBO UNIT WITH BATTERY BACK-UP

PRODUCT FEATURES

- ▶ Dual-Voltage Input 120/277VAC Operation
- ▶ UL Listed for Damp Location
- ▶ Long-lasting, Energy Saving LED Lamps
- ▶ 90 Minutes Minimum Emergency Operation
- ▶ Injection-Molded, 5VA Flame Retardant, High Impact, Thermoplastic
- ▶ Round Fully adjustable LED Lamp Heads packaged inside Exit Sign Housing for petite packaging (0.5W per lamp head)
- ▶ Universal Mounting Pattern
- ▶ Canopy for ceiling mounting included
- ▶ Easy Snap-out Chevrons Directional Indicators
- ▶ Extra Faceplate included for field conversion to Double-Face
- ▶ LED indicator light alerts occupant of battery level
- ▶ Push-to-Test Switch
- ▶ Maintenance-free 3.6V, NiCd Battery
- ▶ Fully automatic operation

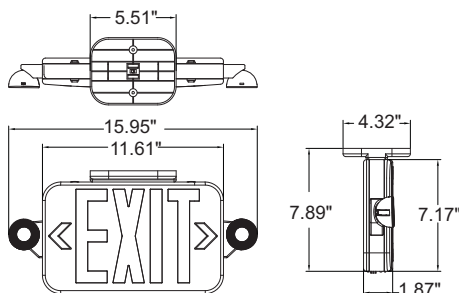

EECMPL-W-R



Emergency Lights ship inside Exit Sign for Space Saving Packaging

Cat. No.	Housing Color	Letter Color	Options
EECMPL	W (White) B (Black)	R (Red) G (Green)	RC (Remote Capacity)

EECLMS

MICRO LED EMERGENCY LIGHT/EXIT SIGN COMBO UNIT WITH BATTERY BACK-UP

PRODUCT FEATURES

- ▶ Dual-Voltage Input 120/277VAC Operation
- ▶ UL Listed for Damp Location
- ▶ Long-lasting, Energy Saving LED Lamps
- ▶ 90 Minutes Minimum Emergency Operation
- ▶ Injection-Molded, 5VA Flame Retardant, High Impact, Thermoplastic
- ▶ Square fully adjustable LED Lamp Heads (0.8W per lamp head)
- ▶ Universal Mounting Pattern
- ▶ Canopy for ceiling mounting included
- ▶ Easy Snap-out Chevrons Directional Indicators
- ▶ Extra Faceplate included for field conversion to Double-Face
- ▶ Push-to-Test Switch
- ▶ Maintenance-free 3.6V, NiCd Battery
- ▶ Fully automatic operation



EECLMS-W-G

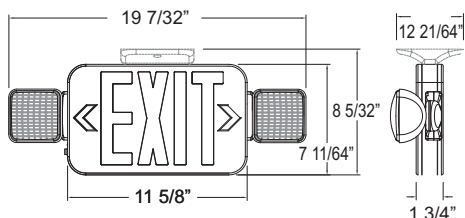

Cat. No.	Housing Color	Letter Color	Options
EECLMS	W (White) B (Black)	R (Red) G (Green)	RC (Remote Capacity)

EECLP-LED

LED TUBE EMERGENCY LIGHT/EXIT SIGN COMBO UNIT WITH BATTERY BACK-UP

PRODUCT FEATURES

- ▶ Dual-Voltage Input 120/277VAC Operation
- ▶ UL Listed for Damp Location
- ▶ Long-lasting, Energy Saving LED Lamps
- ▶ Adjustable LED Emergency Light beneath Exit Sign (2.5W)
- ▶ 90 Minutes Minimum Emergency Operation
- ▶ Injection Molded, 5VA Flame Retardant, High Impact, Thermoplastic
- ▶ Universal Mounting Pattern
- ▶ Canopy for ceiling or end mounting included
- ▶ Easy Snap-out Chevrons Directional Indicators
- ▶ Extra Faceplate included for field conversion to Double-Face
- ▶ Push-to-Test Switch
- ▶ Two Maintenance-free 4.8V NiCd Batteries
- ▶ Fully automatic operation
- ▶ Remote Capable for up to 2 additional Lamp Heads



EECLP-LED-W-1-R

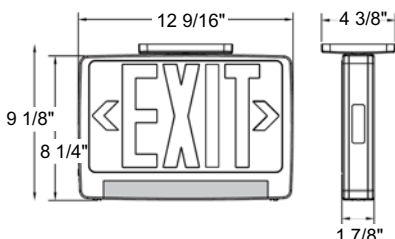

Cat. No.	Housing Color	Letter Color	Options
EECLP-LED	W (White) B (Black)	R (Red) G (Green)	SDT (Self Diagnostic Test)

Exit & Emergency



*EESLA-LED

CAST ALUMINUM LED EMERGENCY LIGHT/
EXIT SIGN COMBO UNIT WITH BATTERY BACK-UP

PRODUCT FEATURES

- ▶ Dual-Voltage Input 120/277VAC Operation
- ▶ UL Listed for Damp Location
- ▶ Long-lasting, Energy Saving LED Lamps
- ▶ Two high powered, fully adjustable LED Lamp Heads (1.5W per lamp head)
- ▶ 90 Minutes Minimum Emergency Operation
- ▶ Heavy-Duty Premium Grade Aluminum Housing
- ▶ Universal Mounting Pattern
- ▶ Aluminum Canopy for ceiling or end mounting included
- ▶ Knockout Chevrons Directional Indicators
- ▶ Push-to-Test Switch
- ▶ Maintenance-free 8.4V NiCd Battery
- ▶ Fully automatic operation



EESLA-LED-A-A-1-G

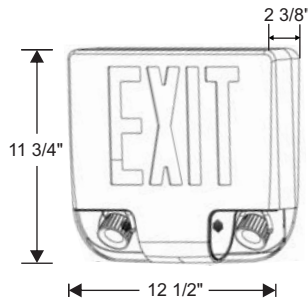

Cat. No.	Housing Color	Faceplate	No. of Faces	Letter Color
*EESLA-LED	A (Aluminum) W (White) B (Black)	A (Aluminum) W (White) B (Black)	1 2	R (Red) G (Green)

*EECLA

EMERGENCY LIGHT/LED EXIT SIGN
COMBO UNIT WITH BATTERY BACK-UP

PRODUCT FEATURES

- ▶ Dual-Voltage Input 120/277VAC Operation
- ▶ UL Listed for Damp Location
- ▶ Two 6V 5.4W T5 Wedge Base Lamp Heads with **fully adjustable lamp arms**
- ▶ Long-lasting, Energy Saving LED Lamps
- ▶ 90 Minutes Minimum Emergency Operation
- ▶ Injection-Molded, 5VA Flame Retardant, High Impact, Thermoplastic
- ▶ Universal Mounting Pattern
- ▶ Canopy for end mounting included
- ▶ Easy Snap-out Chevrons Directional Indicators
- ▶ Extra Faceplate included for field conversion to Double-Face
- ▶ Push-to-Test Switch
- ▶ Maintenance-free 6V, 4.5AH Sealed Lead-Acid Battery
- ▶ Fully automatic operation



EECLA-W-G

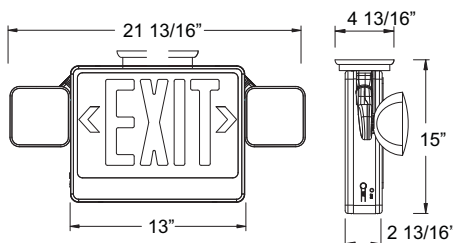

Cat. No.	Housing Color	Letter Color	Options
*EECLA	W (White) B (Black)	R (Red) G (Green)	SDT (Self Diagnostic Test) RC (Remote Capable)

ESLN4M

MICRO WET LOCATION LED EXIT SIGN

PRODUCT FEATURES

- ▶ Dual-Voltage Input 120/277VAC Operation (Except 2C models)
- ▶ UL Listed for Wet Location (-10°C - 40°C)
- ▶ Long-lasting, Energy Saving LED Lamps
- ▶ 90 Minutes Minimum Emergency Operation (**EB Only**)
- ▶ Injection Molded, 5VA Flame Retardant, High Impact, Thermoplastic
- ▶ Fully Gasketed Corrosion-Resistant Enclosure
- ▶ High-Impact Clear Polycarbonate Lens
- ▶ Universal Mounting Plate
- ▶ Canopy for ceiling or end mounting included
- ▶ Easy Snap-out Chevrons Directional Indicators
- ▶ Sealed Push-to-Test Switch
- ▶ Maintenance-free 6V NiCd Battery (**EB Only**)
- ▶ Fully automatic operation (**EB Only**)



ESLN4M-W-1-G

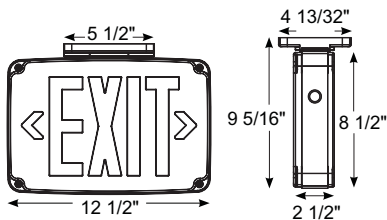

Cat. No.	Housing Color	No. of Faces	Letter Color	Operation	Options
ESLN4M	W (White)	1	R (Red)	EB (Battery Back-Up) AC (AC Only)	SDT (Self Diagnostic Test) 2C-120 (Dual-Circuit Op., 120V) 2C-277 (Dual-Circuit Op., 277V)
	B (Black) GY (Grey)	2	G (Green)		

EESL2L

MICRO WET LOCATION LED EMERGENCY LIGHT/EXIT SIGN COMBO UNIT

PRODUCT FEATURES

- ▶ Dual-Voltage Input 120/277VAC Operation
- ▶ UL Listed for Wet Location (-20°C ~ 50°C)
- ▶ Long-lasting, Energy Saving LED Lamps
- ▶ Round fully adjustable LED Lamp Heads (1W per lamp head)
- ▶ 90 Minutes Minimum Emergency Operation
- ▶ Injection Molded, 5VA Flame Retardant, High Impact, Thermoplastic
- ▶ Fully Gasketed Corrosion-Resistant Enclosure
- ▶ High-Impact Clear Polycarbonate Lens
- ▶ Universal Mounting Plate
- ▶ Easy Snap-out Chevrons Directional Indicators
- ▶ Sealed Push-to-Test Switch
- ▶ White housing only
- ▶ Maintenance-free 3.6V NiCd Battery
- ▶ Fully automatic operation
- ▶ RC option offers additional 3W for 90 min.

NEW



EESL2L-R

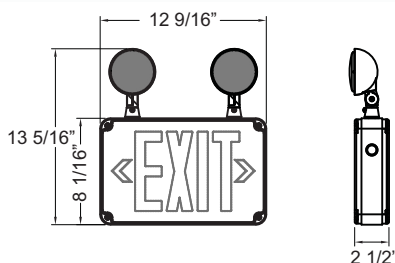

Cat. No.	Letter Color	No. of Faces	Options
EESL2L	R (Red)	1	SDT (Self Diagnostic Test) RC (Remote Capacity) HTR (Internal Heater)
	G (Green)	2	

Exit & Emergency



ESBL2L

WET LOCATION LED EMERGENCY LIGHT/EXIT SIGN
COMBO UNIT WITH BATTERY BACK-UP

PRODUCT FEATURES

- ▶ Dual-Voltage Input 120/277VAC Operation
- ▶ UL Listed for Wet Location
- ▶ Suitable for cold weather **with heater option** (-20°C - 50°C)
- ▶ Long-lasting, Energy Saving LED Lamps
- ▶ Two 3.6W adjustable Waterproof LED Bulbs
- ▶ 90 Minutes Minimum Emergency Operation
- ▶ Injection Molded, 5VA Flame Retardant, Polycarbonate
- ▶ Fully Gasketed Corrosion-Resistant Enclosure
- ▶ High-Impact UV Resistant, Polycarbonate Lens
- ▶ Universal Mounting Plate for wall mounting
- ▶ Canopy for ceiling or end mounting included
- ▶ Easy Snap-out Chevrons Directional Indicators
- ▶ LED indicator light showing battery condition (Green= Normal, Red= Check)
- ▶ Maintenance-free 6V NiCd Battery
- ▶ Fully automatic operation



ESBL2L-GY-1-R

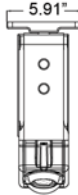
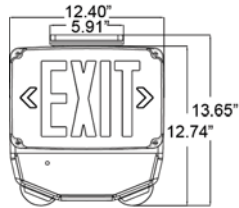

Cat. No.	Housing Color	No. of Faces	Letter Color	Options
ESBL2L	W (White)	1	R (Red)	SDT (Self Diagnostic Test) RC (Remote Capable) TP (Tamper-Proof) HTR (Internal Heater)
	B (Black) GY (Grey)	2	G (Green)	



LRHS-1



LRHS-2

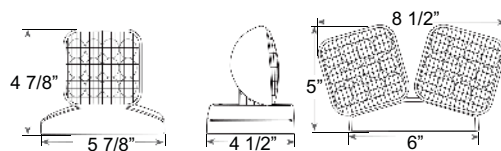

NEW



LRHR-1

NEW



LRHR-2

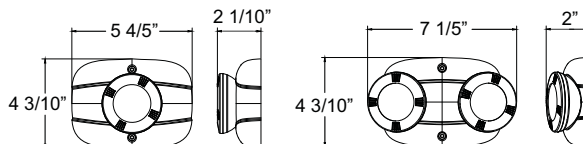

LRHS-WP-1



LRHS-WP-2

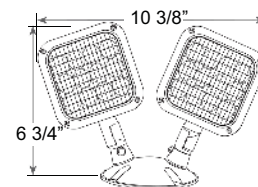
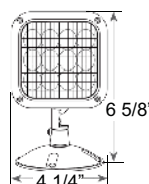

PRODUCT FEATURES

- ▶ Adjustable heads to increase center-to-center spacing
- ▶ Mounting hardware included
- ▶ Suitable for ceiling or end Mounting

Cat. No.	No. of Heads	Voltage	Housing Color	Wattage
LRHS (Square LED Remote Head)	1	MV (3.6V, 6V, 9.6V & 12V)	W (White)	Blank (1W per Head)
	2		B (Black)	HO (1.5W per Head)
NEW LRHR (Round LED Remote Head)	1	3 (3.2V)	W (White)	4 (3.6W Total)
	2			6 (6.3W Total)
				13 (12.8W Total)
LRHS-WP (Outdoor Square LED Remote)	1	MV (3.6V, 6V, 9.6V & 12V)	GY (Grey)	Blank (1W per Head)
	2		B (Black)	HO (1.5W per Head)

Exit & Emergency



PCS SERIES ENVIRONMENTAL SHIELDS



PCS-R
Shown Installed



PCS-D
Shown Installed

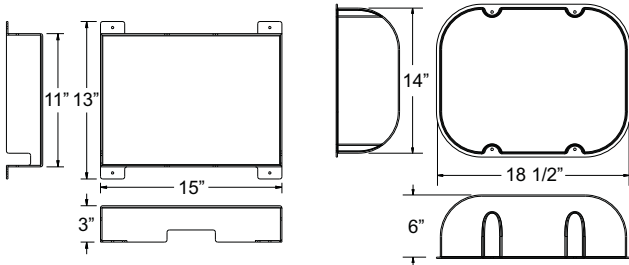

Cat. No.	Description
PCS-R	Polycarbonate Vandal/Environmental Rectangular Shield
PCS-D	Polycarbonate Vandal/Environmental Dome Shield

Exit & Emergency

WG SERIES WIRE GUARDS



WG-15



WG-30
Shown Installed

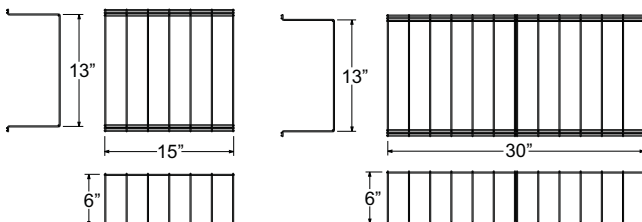

Cat. No.	Description
WG-15	15" Wire Guard Covers most Emergency Units
WG-30	30" Wire Guard Covers most Exits & Combo Units



EB-24



EB-36



EB-36HO



EB-48



EB-6



EB-96



*EIB-5



*EHB-5

BATTERIES

Cat No.	Description	For Use With
EB-24	2.4V, 900mAH, NiCd Battery	ESLAM
EB-36	3.6V, 900mAH, NiCd Battery	EL2NM-LED, EL2HM-LED, EL2FM-LED, EL2SML, EL2H-WP-LED, EECMPL, EECLM-LED, EECLMS
EB-36HO	3.6V, 1800mAH, NiCd Battery for High Output	EL2NM-LED-HO
EB-48	4.8V, 650-700mAH NiCd Replacement Battery	EL1DOL, ESBL, ESL2C, ESLA, ESSE, ESRE, EECLP-LED, ESBL2N4
EB-6	6V, 4.5AH Sealed Lead-Acid Cadmium Replacement Battery	EL2LR, EL2T, EL2H-WP, EL2TN4, EECLA, ESLN4M, ESLN4M, ESBL2L
EB-96	9.6V NiCd Battery	EL2TN4-LED

LAMPS

Cat No.	Description	For Use With
*EIB-5	6V, 5W Wedge-Base Incandescent Lamp	All Orbit Wedge-Base Incandescent Units
*EHB-5	6V, 5W MR16 Halogen Lamp	EL2H, ESBL2H

LED RETROFIT KITS

PRODUCT FEATURES

- ▶ 120 VAC
- ▶ 2.8W per Kit (Set of Two LED Base)
- ▶ Mounting Bracket and Double-Sided Tape included (LRK-HW)
- ▶ Socket Adapters (Bayonet, Intermediate or Candelabra) Included (LRK-SI)

Cat No.	Description
LRK-SI-R	Screw-In Red LED Retrofit Kit
LRK-SI-G	Screw-In Green LED Retrofit Kit

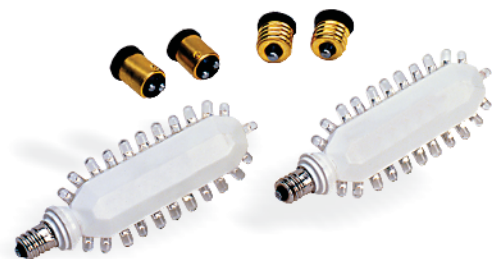

LRK-SI

*While Supplies Last

J20 | LED Emergency Ballasts



LBAL SERIES

LED EMERGENCY LIGHTING BALLASTS

PRODUCT FEATURES

- ▶ Dual-Voltage Input 120/277VAC Operation
- ▶ UL Classified for field installation
- ▶ Suitable for Damp Location (0°C - 50°C)
- ▶ Provides constant power output to the load during emergency mode operation
- ▶ 90 minute minimum emergency operation over full temperature range
- ▶ Injection Molded, engineering grade, 5VA Flame Retardant, high-impact, thermoplastic
- ▶ Black finish
- ▶ Installs inside, on top, or in remote of the fixture
- ▶ Output short/overcurrent protection: Electronic limiting, with normal operation resuming upon removal of fault
- ▶ Can be operated as NORMALLY-ON, NORMALLY-OFF or SWITCHED LOAD
- ▶ Output classification: Class 2 Compliant
- ▶ Surge protection: Per C62.41 (TVS)
- ▶ Input overcurrent protection: Fusible Link
- ▶ LED illuminated and remote mounted test switch
- ▶ Charge/Power "ON" LED indicator light and push-to-test switch
- ▶ Maintenance-free, rechargeable NiCd Battery
- ▶ 24 Hour max battery recharge time
- ▶ 5 year warranty on electronics and housing
- ▶ Meets UL924, NFPA 101 Life Safety Code

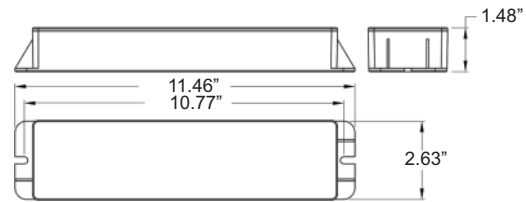
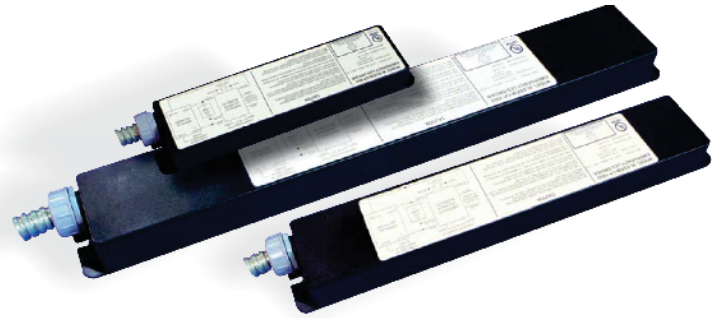

LBAL800

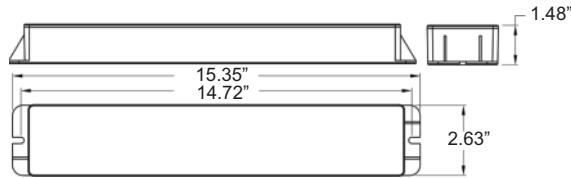

LBAL1200 & 1600

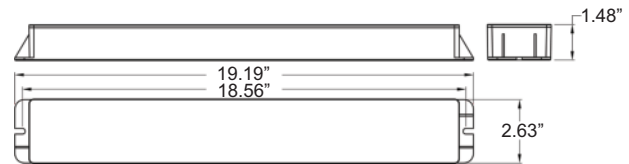

LBAL2000 & 2400

Exit & Emergency

Cat.No.	OUTPUT OPERATING RANGE		OUTPUT POWER		Input Current (A)	Input Power (W)
	Voltage (Vdc)	Current (mA _{dc})	System Wattage (Constant)	Lumens		
LBAL800	20 -50	250 -100	5	800	0.061	3.9
LBAL1200	20 -50	390 -156	7.8	1250	0.065	4.8
LBAL1600	20 -50	535 -214	10.7	1700	0.087	5.7
LBAL2000	20 -50	685 -274	13.7	2200	0.11	6.9
LBAL2400	20 -50	850 -340	17	2700	0.11	7.9

*Lumen output based on LED light source having efficacy of 160 lumens/watt. Actual output may vary depending on light source.

EASY ACCESS LIGHTING BOX 2-1/8" DEEP 30.3 Cu. In.

PRODUCT FEATURES

- ▶ Fast and efficient installations
- ▶ Sliding cover plate for one person installations
- ▶ Swivel reduces damage to hanging fixtures when struck
- ▶ Complies with NEC 314.27 (A)(D) for up to 90 lbs. of fixture load



Cat. No.	Description	Dimensions (W x H)	Knockouts		Std. Pkg.
			Sides	Bottom	
EALBS	Easy Access Lighting Box with Sliding Swivel	4" X 4"	4 - CKO	3 - 1/2", 1 - 3/4"	10

Only box UL-Listed for up to 90lbs of fixture load!

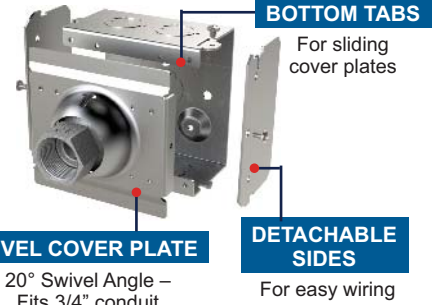

PATENTED



Video Available On Our Website!

50% LABOR SAVINGS

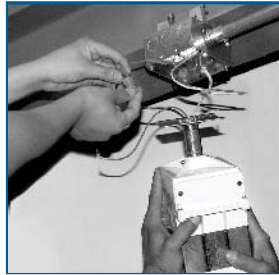

TRADITIONAL METHOD

Requires two installers



WITH ORBIT'S EALBS

Install Swivel Plate on lighting fixture and slide it into the box. One installer completes wiring while fixture hangs

CONDUIT LOCKING CONNECTOR

PRODUCT FEATURES

- ▶ Steel
- ▶ Fits 4", 4-11/16" sq. and 4O boxes as well as Orbit's patented EALBS
- ▶ Hooks prevent rotation of fixtures such as security cameras and emergency lighting
- ▶ Holes allow for branch line restraints
- ▶ Includes set-screw and locknut
- ▶ Can replace Rigid Threaded Conduit Fittings



Video Available On Our Website!

PATENTED



Cat. No.	Description	Trade Size	Std. Pkg.	Mst. Ctn.
CLCSL-50	1/2" Conduit Locking Connector with Seismic Wire Holes	1/2"	10	100
CLCSL-75	3/4" Conduit Locking Connector with Seismic Wire Holes	3/4"	10	100



CLCSL



Locknut Included



Before Installation



After Installation Prevents Rotation

Exit & Emergency





CHAPTER 1 ADMINISTRATION

1.1 Scope.

1.1.1 Title. NFPA 101, Life Safety Code, shall be known as the Life Safety Code®, is cited as such, and shall be referred to herein as "this Code" or "the Code".

1.1.2 Danger to Life from Fire. The Code addresses those construction, protection, and occupancy features necessary to minimize danger to life from the effects of fire, including smoke, heat, and toxic gases created during a fire.

1.1.3 Egress Facilities. The Code establishes minimum criteria for the design of egress facilities so as to allow prompt escape of occupants from buildings or, where desirable, into safe areas within buildings.

1.1.4 Other Fire-Related Considerations. The Code addresses other considerations that are essential to life safety in recognition of the fact that life safety is more than a matter of egress. The Code also addresses protective features and systems, building services, operating features, maintenance activities, and other provisions in recognition of the fact that achieving an acceptable degree of life safety depends on additional safeguards to provide adequate egress time or protection for people exposed to fire.

1.1.5 Hazardous Materials Emergencies. The Code also addresses other considerations that provide for occupant protection during emergency events involving hazardous materials.

1.1.6 Injuries from Falls. The Code also addresses reducing injury to occupants from falls.

1.1.7 Emergency Communications. The Code also addresses other considerations that provide for communications to occupants under emergency conditions and to others.

1.1.8 Considerations Not Related to Fire. The Code also addresses other considerations that, while important in fire conditions, provide an ongoing benefit in other conditions of use, including non-fire emergencies.

1.1.9 Areas Not Addressed. The Code does not address the following:

- (1) General fire prevention or building construction features that are normally a function of fire prevention codes and building codes
- (2) Prevention of injury incurred by an individual due to that individual's failure to use reasonable care
- (3) Preservation of property from loss by fire
- (4) The retail sale and associated storage of consumer fire-works

1.2 Purpose. The Purpose of this Code is to provide minimum requirements, with due regard to function, for the design, operation, and maintenance of buildings and structures for safety to life from fire. Its provisions will also aid life safety in similar emergencies.

1.3 Application.

1.3.1 New and Existing Buildings and Structures. The Code shall apply to both new construction and existing buildings and existing structures.

1.3.2 Vehicles and Vessels. The Code shall apply to vehicles, vessels, or other similar conveyances, as specified in Section 11.6, in which case such vehicles and vessels shall be treated as buildings.

1.4 Equivalency. Nothing in this Code is intended to prevent the use of systems, methods, or devices of equivalent or superior quality, strength, fire resistance, effectiveness, durability, and safety over those prescribed by this Code.

1.4.1 Technical Documentation. Technical documentation shall be submitted to the authority having jurisdiction to demonstrate equivalency.

1.4.2 Approval. The system, method, or device shall be approved for the intended purpose by the authority having jurisdiction.

1.4.3 Equivalent Compliance. Alternative systems, methods, or devices approved as equivalent by the authority having jurisdiction

shall be recognized as being in compliance with this Code.

1.5 Units and Formulas.

1.5.1 SI Units. Metric units of measurement in this Code are in accordance with the modernized metric system known as the International System of Units (SI).

1.5.2 Primary Values. The inch-pound value for a measurement, and the SI value given in parentheses, shall each be acceptable for use as primary units for satisfying the requirements of this Code.

1.6 Enforcement. This Code shall be administered and enforced by the authority having jurisdiction designated by the governing authority.

CHAPTER 7 MEANS OF EGRESS

7.9 Emergency Lighting.

7.9.1 General.

7.9.1.1 Emergency lighting facilities for means of egress shall be provided in accordance with Section 7.9 for the following:

- (1) Buildings or structures where required in Chapters 11 through 43
- (2) Underground and limited access structures as addressed in Section 11.7
- (3) High-rise buildings as required by other sections of this Code
- (4) Doors equipped with delayed-egress locks
- (5) Stair shafts and vestibules of smokeproof enclosures, for which the following also apply:
 - (a) The stair shaft and vestibule shall be permitted to include a standby generator that is installed for the smokeproof enclosure mechanical ventilation equipment.
 - (b) The standby generator shall be permitted to be used for the stair shaft and vestibule emergency lighting power supply.
- (6) New sensor-release of electrical locking systems in accordance with 7.2.1.6.2

7.9.1.2 For the purposes of 7.9.1.1, exit access shall include only designated stairs, aisles, corridors, ramps, escalators, and passageways leading to an exit. For the purpose of 7.9.1.1, exit discharge shall include only designated stairs, ramps, aisles, walkways, and escalators leading to a public way.

7.9.1.3 Where maintenance of illumination depends upon changing from one energy source to another, a delay of not more than 10 seconds shall be permitted.

7.9.2 Performance of System.

7.9.2.1 Emergency illumination shall be provided for not less than 1½ hours in the event of failure of normal lighting.

7.9.2.1.1 Emergency lighting facilities shall be arranged to provide initial illumination that is no less than an average of 1 ft-candle (10.8 lux) and, at any point, not less than 0.1 ft-candle (1.1 lux), measured along the path of egress at floor level.

7.9.2.1.2 Illumination levels shall be permitted to decline to not less than an average of 0.6 ft-candle (6.5 lux) and, at any point, not less than 0.06 ft-candle (0.65 lux) at the end of the 1½ hours.

7.9.2.1.3 A maximum-to-minimum illumination shall not exceed a ratio of 40 to 1.

7.9.2.2 New emergency power systems for emergency lighting shall be at least Type 10, Class 1.5, Level 1, in accordance with NFPA 110.

7.9.2.3 The emergency lighting system shall be arranged to provide the required illumination automatically in the event of any interruption of normal lighting due to any of the following:

- (1) Failure of public utility or other outside electrical power supply
- (2) Opening of a circuit breaker or fuse
- (3) Manual act(s), including accidental opening of a switch controlling normal lighting facilities.

7.9.2.4 Emergency generators and related transfer switch equipment that provide power to emergency lighting systems shall be installed, inspected, tested, and maintained in accordance with NFPA 110. Stored electrical energy systems, where required in this Code, other than battery systems for emergency luminaires in accordance with NFPA 7.9.2.5, shall be installed, inspected, tested, and maintained in accordance with NFPA 111.

7.9.2.5 Unit equipment and battery systems for emergency luminaires shall be listed to ANSI/UL 924, Standard for Emergency Lighting and Power Equipment.

7.9.2.6 Existing battery-operated emergency lights shall use only reliable types of rechargeable batteries provided with suitable facilities for maintaining them in properly charged condition. Batteries used in such lights or units shall be approved for their intended use and shall comply with NFPA 70.

7.9.2.7 The emergency lighting system shall be either continuously in operation or capable of repeated automatic operation without manual intervention.

7.9.3 Periodic Testing of Emergency Lighting Equipment.

7.9.3.1 Required emergency lighting systems shall be tested in accordance with one of the four options offered by 7.9.3.1.1, 7.9.3.1.2, 7.9.3.1.3, or 7.9.3.1.4.

7.9.3.1.1 Testing of required emergency lighting systems shall be permitted to be conducted as follows:

- (1) Functional testing shall be conducted monthly, with a minimum of 3 weeks and a maximum of 5 weeks between tests, for not less than 30 seconds, except as otherwise permitted by 7.9.3.1.1(2).
- (2) The test interval shall be permitted to be extended beyond 30 days with the approval of the authority having jurisdiction.
- (3) Functional testing shall be conducted annually for a minimum of 1½ hours if the emergency lighting system is battery powered.
- (4) The emergency lighting equipment shall be fully operational for the duration of the tests required by 7.9.3.1.1(2) and 7.9.3.1.1(3).
- (5) Written records of visual inspections and tests shall be kept by the owner for inspection by the authority having jurisdiction.

7.9.3.1.2 Testing of required emergency lighting systems shall be permitted to be conducted as follows:

- (1) Self-testing/self-diagnostic emergency battery-operated emergency lighting equipment shall be provided.
- (2) Not less than once every 30 days, self-testing/self-diagnostic battery-operated emergency lighting equipment shall automatically perform a test with a duration of a minimum 30 seconds and a diagnostic routine.
- (3) Self-testing/self-diagnostic battery-operated emergency lighting equipment shall indicate failures by a status indicator.
- (4) A visual inspection shall be performed at intervals not exceeding 30 days.
- (5) Functional testing shall be conducted annually for a minimum of 1½-hours.
- (6) Self-testing/self-diagnostic battery-operated emergency lighting equipment shall be fully operational for the duration of the 1½-hour test.
- (7) Written records of visual inspections and test shall be kept by the owner for inspection by the authority having jurisdiction.

7.9.3.1.3 Testing of required emergency lighting systems shall be permitted to be conducted as follows:

- (1) Computer-based, self-testing/self-diagnostic battery operated emergency lighting equipment shall be provided.
- (2) Not less than once every 30 days, emergency lighting equipment shall automatically perform a test with a duration of a minimum of 30 seconds and a diagnostic routine.
- (3) The emergency lighting equipment shall automatically perform annually a test for a minimum of 1½ hours.
- (4) The emergency lighting equipment shall be fully operational for the duration of the tests required by 7.9.3.1.3(2) and 7.9.3.1.3(3).
- (5) The computer-based system shall be capable of providing a report of the history of tests and failures at all times.

7.9.3.1.4 Testing of required emergency lighting systems shall be permitted to be conducted in accordance with 7.9.2.4.

7.10 Marking Of Means Of Egress

7.10.1 General.

7.10.1.1 Where Required. Means of egress shall be marked in accordance with Section 7.10 where required in Chapters 11 through Chapter 43.

7.10.2 Exits.

7.10.1.2.1 Exits, other than main exterior exit doors that obviously and clearly are identifiable as exits, shall be marked by an approved sign that is readily visible from any direction of exit access.

7.10.1.2.2 Horizontal components of the egress path within an exit enclosure shall be marked by approved exit or directional exit signs where the continuation of the egress path is not obvious.

7.10.1.3 Exit Door Tactile Signage. Tactile signage shall be provided to meet all the following criteria, unless otherwise provided in 7.10.1.4:

- (1) Tactile signage shall be located at each door requiring an exit sign.
- (2) Tactile signage shall read as follows: EXIT.
- (3) Tactile signage shall comply with ICC/ANSI A117.1, Accessible and Usable Buildings and Facilities.

7.10.1.4 Existing Exemption. The requirements of 7.10.1.3 shall not apply to existing buildings, provided that the occupancy classification does not change.

7.10.1.5 Exit Access.

7.10.1.5.1 Access to exits shall be marked by approved, readily visible signs in all cases where the exit or way to reach the exit is not readily apparent to the occupants.

7.10.1.5.2 New sign placement shall be such that no point in the exit access corridor is in excess of the rated viewing distance or 100 ft (30m), whichever is less, from the nearest sign.

7.10.1.6 Floor Proximity Exit Signs. Where floor proximity exit signs are required in Chapters 11 through 43, such signs shall comply with 7.10.3, 7.10.4, 7.10.5, and 7.10.6 for externally illuminated signs and 7.10.7 for internally illuminated signs. Such signs shall be located near the floor level in addition to those signs required for doors or corridors. The bottom of the sign shall be not less than 6 in. (150 mm), but not more than 18 in. (455 mm), above the floor. For exit doors, the sign shall be mounted on the door or adjacent to the door, with the nearest edge of the sign within 4 in. (100 mm) of the door frame.

7.10.1.7 Floor Proximity Egress Path Marking. Where floor proximity egress path marking is required in Chapters 11 through 43, an approved floor proximity egress path marking system that is internally illuminated shall be installed within 18 in. (455 mm) of the floor. Floor proximity egress path marking systems shall be listed in accordance with ANSI/UL 1994, Standard for Luminous Egress Path Marking Systems. The system shall provide a visible delineation of the path of travel along the designated exit access and shall be essentially continuous, except as interrupted by doorways, hallways, corridors, or other such architectural features. The system shall operate continuously or at any time the building fire alarm is activated. The activation, duration, and continuity of operation of the system shall be in accordance with 7.9.2. The system shall be maintained in accordance with the product manufacturing listing.

7.10.1.8 Visibility. Every sign required in Section 7.10 shall be located and of such size, distinctive color, and design that it is readily visible and shall provide contrast with decorations, interior finish, or other signs. No decorations, furnishings, or equipment that impairs visibility of a sign shall be permitted. No brightly illuminated sign (for other than exit purposes), display, or object in or near the line of vision of the required exit sign that could detract attention from the exit sign shall be permitted.



7.10.1.9 Mounting Location. The bottom of new egress markings shall be located at a vertical distance of not more than 6 ft 8 in. (2030 mm) above the top edge of the egress opening intended for designation by that marking. Egress markings shall be located at a horizontal distance of not more than the required width of the egress opening, as measured from the edge of the egress opening intended for designation by that marking to the nearest edge of the marking.

7.10.2 Directional Signs.

7.10.2.1 A sign complying with 7.10.3, with a directional indicator showing the direction of travel, shall be placed in every location where the direction of travel to reach the nearest exit is not apparent.

7.10.2.2 Directional exit signs shall be provided within horizontal components of the egress path within exit enclosures as required by 7.10.1.2.2.

7.10.3 Sign Legend.

7.10.3.1 Signs required by 7.10.1 and 7.10.2 shall read as follows in plainly legible letters, or other appropriate wording shall be used: **EXIT**

7.10.3.2 Where approved by the authority having jurisdiction, pictograms in compliance with NFPA 170 shall be permitted.

7.10.4 Power Source. Where emergency lighting facilities are required by the applicable provisions of Chapter 11 through Chapter 43 for individual occupancies, the signs, other than approved self-luminous signs and listed photoluminescent signs in accordance with 7.10.7.2, shall be illuminated by the emergency lighting facilities. The level of illumination of the signs shall be in accordance with 7.10.6.3 or 7.10.7 for the required emergency lighting duration as specified in 7.9.2.1. However, the level of illumination shall be permitted to decline to 60 percent at the end of the emergency lighting duration.

7.10.5 Illumination of Signs.

7.10.5.1 General. Every sign required by 7.10.1.2 or 7.10.1.5, or 7.10.8.1, other than where operations or processes require low lighting levels, shall be suitably illuminated by a reliable light source. Externally and internally illuminated signs shall be legible in both the normal and emergency lighting mode.

7.10.5.2 Continuous Illumination.

7.10.5.2.1 Every sign required to be illuminated by 7.10.6.3, 7.10.7, and 7.10.8.1 shall be continuously illuminated as required under the provisions of Section 7.8, unless otherwise provided in 7.10.5.2.2.

7.10.5.2.2 Illumination for signs shall be permitted to flash on and off upon activation of the fire alarm system.

7.10.6 Externally Illuminated Signs.

7.10.6.1 Size of Signs.

7.10.6.1.1 Externally illuminated signs required by 7.10.1 and 7.10.2, other than approved existing signs, unless otherwise provided in 7.10.6.1.2, shall read EXIT or shall use other appropriate wording in plainly legible letters sized as follows:

- (1) For new signs, the letters shall be not less than 6 in. (150 mm) high, with the principal strokes of letters not less than 3/4 in. (19mm) wide.
- (2) For existing signs, the required wording shall be permitted to be plainly legible letters not less than 4 in. (100 mm) high.
- (3) The word EXIT shall be in letters of a width not less than 2 in. (51mm), except the letter I, and the minimum spacing between letters shall be not less than 3/8 in. (9.5 mm).
- (4) Sign legend elements larger than the minimum established in 7.10.6.1.1(1) through 7.10.6.1.1(3) shall use letter widths, strokes, and spacing in proportion to their height.

7.10.6.1.2 The requirements of 7.10.6.1.1 shall not apply to marking required by 7.10.1.3 and 7.10.1.7.

7.10.6.2 Size and location of Directional Indicator.

7.10.6.2.1 Directional indicators, unless otherwise provided in 7.10.6.2.2, shall comply with the following:

- (1) The directional indicator shall be located outside of the EXIT legend, not less than 3/8 in. (9.5 mm) from any letter.
- (2) The directional indicator shall be of a chevron type, as shown in Figure 7.10.6.2.1.
- (3) The directional indicator shall be identifiable as a directional indicator at a distance of 40 ft (12 m).
- (4) A directional indicator larger than the minimum established for compliance with 7.10.6.2.1(3) shall be proportionately increased in height, width, and stroke.
- (5) The directional indicator shall be located at the end of the sign for the direction indicated.

7.10.6.2.2 The requirements of 7.10.6.2.1 shall not apply to approved existing signs.

7.10.6.3 Level of Illumination. Externally illuminated signs shall be illuminated by not less than 5 ft-candles (54 lux) at the illuminated surface and shall have a contrast ratio of not less than 0.5.

7.10.7 Internally Illuminated Signs.

7.10.7.1 Listing. Internally illuminated signs shall be listed in accordance with UL 924, Emergency Lighting and Power Equipment, unless they meet one of the following criteria:



FIGURE 7.10.6.2.1 Chevron-Type Indicator.

- (1) They are approved existing signs.
- (2) They are existing signs having the required wording in legible letters not less than 4 in. (100 mm) high.
- (3) They are signs that are in accordance with 7.10.1.3 and 7.10.1.6.

7.10.7.2 Photoluminescent Signs. The face of a photoluminescent sign shall be continually illuminated while the building is occupied. The illumination levels on the face of the photoluminescent sign shall be in accordance with its listing. The charging illumination shall be a reliable light source, as determined by the authority having jurisdiction. The charging light source, shall be of a type specified in the product markings.

7.10.8 Special Signs.

7.10.8.1 Sign Illumination.

7.10.8.1.1 Where required by other provisions of this Code, special signs shall be illuminated in accordance with 7.10.5, 7.10.6.3, and 7.10.7.

7.10.8.1.2 Where emergency lighting facilities are required by the applicable provisions of Chapters 11 through 43, the required illumination of special signs shall additionally be provided under emergency lighting conditions.

7.10.8.2 Characters. Special signs, where required by other provisions of this Code, shall comply with the visual character requirements of ICC/ANSI A117.1, American National Standard for Accessible and Usable Buildings and Facilities.

NFPA 101 Life Safety Code® 2021 Edition Life Safety Code® and NFPA 101® are registered trademarks of the National Fire Protection Association, Inc.