

BOX BRACKETS, FASTENERS & STRAPS CROSS REFERENCE

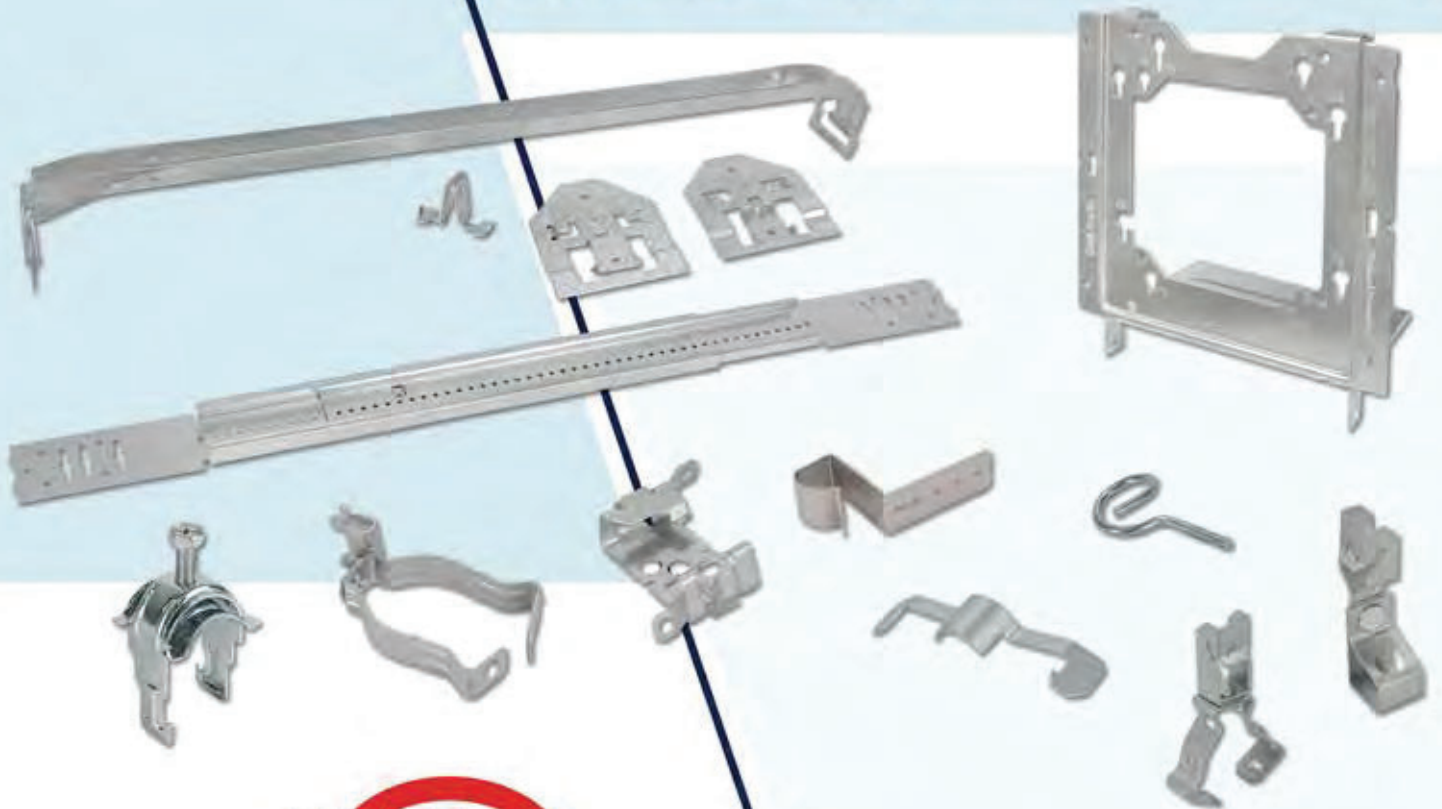

orbit[®]
Orbit Industries, Inc.

ORBPAM-6

































Image	Orbit #	Caddy #	B-Line #	Std. Pkg
Fixed & Adjustable Stud Brackets				
	TSB	TSRBS1625	-	25
	BHA-16	TSGB16	BB2-16T	50
	BHA-24	TSGB1624	BB2-24T	50
	BARB	TSLDR1	BB2TSC	50
	BARB-CS	BARB w/ built-in Cable Support		50
	FMB-16	RBS16	BB8-16	25
	FMB-24	RBS24	BB8-24	25
	MBBH-16	RBS16	BB7-16	50
	MBBH-24	RBS24	BB7-24	50
	UMA-LVBS	TEB23 or STS2346	BB73	25
	BMA-23	H23 or C23	BB4-23	25
	BMA-4	H4 or C4	BB4-4	25
	FS-456-EXT	Far-side Support Extender for up to 6" Deep Studs, tool-less		50
	LVS1	MP1S	BB15	50
	LVS2	MP2S	-	25
Box & Conduit Support				
	BCHS-10	B18SBT18	BG-6-S18 or BG6-S18-MC3	25
	BCHS-6	B18SBT18Z	BG-6-S18-W6 or BG6-S18-W6-MC3 or BG6-S18-W2-MC3	10
	F6MB18A	6MB18A	BG6-S18	25
	F812MB18A	812MB18A	BG812-S18	25
	F812MB18S	812MB18S	BG812-S18S	25
	F16MB18A	16MB18A	BG16-S18	25

Image	Orbit #	Caddy #	B-Line #	Std. Pkg	
Cable & Conduit Supports					
	CS-CJ6	CJ6	BRC6M	100	
	BMCS	Box Mounted Cable Support		50	
	BMCS-CJ6	Box Mounted Cable Support w/ CS-CJ6		50	
	FFXC20	FXC20	BX5	100	
	FMAC2	MAC2	BX4M	100	
	MSC	449	BX9	100	
	FSC2A	SC2A	BXS-67	100	
	FSC2D	SC2D	BXS-1214	100	
	FSC2E	SC2E	BXS-1519	100	
	FSC2F	SC2F	BXS-2024	100	
	FSC4B	SC4B	BXM-89	100	
	FSC4D	SC4D	BXM-1214	100	
	FCS812	CS812	BB38	100	
	FCS812D	CS812D	BB38D	100	
	FCS16	CS16	-	100	
	F6M4I	6M4I	BG-6-4T	100	
	F812M4I	812M4I	BG-8-12-4T	100	
	F16M4I	16M4I	BG-16-4T	100	
	F20M4I	20M4I	BG-20-4T	100	
	F24M4I	24M4I	BG-24-4T	100	
	F32M4I	32M4I	BG-32-4T	100	
	F6M	6M	BG-6	100	
	F812M	812M	BG-8-12	100	
	F16M	16M	BG-16	100	
	F20M	20M	BG-20	100	
	F24M	24M	BG-24	100	
	F32M	32M	BG-32	100	
		F6M24SM	6M24SM	BG-6-E-2-4	100
		F6M912SM	6M912SM	BG-6-E-9-12	100
F812M24SM		812M24SM	BG-8-12-E-2-4	100	
F812M58SM		812M58SM	BG-8-12-E-5-8	100	
F812M912SM		812M912SM	BG-8-12-E-9-12	100	
F16M24SM		16M24SM	BG-16-E-2-4	100	
F16M58SM		16M58SM	BG-16-E-5-8	100	
F16M912SM		16M912SM	BG-16-E-9-12	50	
F20M24SM		20M24SM	BG-20-E-2-4	100	
F20M58SM		20M58SM	BG-20-E-5-8	100	
F20M912SM		20M912SM	BG-20-E-9-12	100	
F24M24SM		24M24SM	BG-24-E-2-4	50	
F24M58SM		24M58SM	BG-24-E-5-8	50	
F24M912SM		24M912SM	BG-24-E-9-12	50	
F32M24SM	32M24SM	BG-32-E-2-4	50		
F32M58SM	32M58SM	BG-32-E-5-8	50		
F32M912SM	32M912SM	BG-32-E-9-12	50		

CABLE & CONDUIT SUPPORTS

Image	Orbit #	Caddy #	B-Line #	Std. Pkg
Beam Clamps, Perlin Clips & Acoustical Clips				
	FMSR122	-	BH-F12	50
	FMSR58	MSR58	BH-5-8-R	50
	FMSS122	MSS122	BH-F12-R	50
	FMSS24	MSS24	BH-2-4	50
	FMSS58	MSS58	BH-5-8	50
	FMSS912	MSS912	BH-9-12	50
	FRMX58	RMX58	BH-F12	100
	F2H4	2H4	BE-1-2	100
	F4H24	4H24	BE-2-4	100
	F4H58	4H58	BE-5-8	100
	F4H912	4H912	BE-9-12	100
	F122	122	BF12	100
	F1226TI	1226TI	BH6-F12	100
	F4TI24	4TI24	BH4-E-2-4	100
	F4TI58	4TI58	BH4-E-5-8	100
	F4TI912	4TI912	BH4-E-9-12	100
	F6A24	6A24	BH2-E-2-4	100
	F6A912	6A912	BH2-E-9-12	100
	F4G16	4G16	BA-4-16	100
	F4G16H	4G16H	BA-4-16-H	100
	ISC	IDC	BA1	100
	F4Z34	4Z34	BW2	100
	F6Z34	6Z34	BW6	100
	F4Z4S	4Z4S	BW2S	100
	F6Z4S	6Z4S	BW6S	100

Image	Orbit #	Caddy #	B-Line #	Std. Pkg
Datacom				
	F2BRT12	2BRT12	BR-12-T	100
	F2BRT20	2BRT20	BR-20-T	100
	F2BRT32	2BRT32	BR-32-T	100
	F4BRT20	4BRT20	BR-20-4T	100
	F4BRT32	4BRT32	BR-32-4T	100
	F4BRT64	4BRT64	BR-64-4T	50
	FCAT12	CAT12	BCH12	50
	*FCAT21	CAT21HP	BCH21	50
	*FCAT32	CAT32HP	BCH32	50
	*FCAT64	CAT64HP	BCH64	25
	FCAT124Z34	CAT124Z34	BCH12-W2	40
	FCAT126Z34	CAT126Z34	BCH12-W6	60
	MPC	2FMP28	-	100

* Cable retainer not included

Image	Orbit #	Caddy #	B-Line #	Std. Pkg
Miscellaneous				
	F4TI	4TI	BH4	100
	F6TI	6TI	BH6	100
	F6T	6T	BH5	100
	F4TIB	4TIB	BH4-H7	100
	F6TIB	6TIB	BH6-H7	100
	AB4	AB	BH7	100
	AB6	AB375	BH7-6	100
	JC-12	770	BH9	100
	SP-1	005275150PL	BM3	100
	SP-1-500	005275150PL	BM3	500
	SP-6	005550150PL	-	100
	SOSP	304B2	BM3M	100
	SBS	DS12A	BB33L	100
	LVWP1	MPLS	BB10L	50
	LVWP2	MPLS2	BB20L	25
	DLR-1G	RLC	BB32	50
	HOSP	740	BD40	100
	UCIA-4S	Cut-in Adapter for 4" Sq. Box		20
	FA-UCIA-4S	Red Cut-in Adapter for 4" Sq. Box		20



CABLE & CONDUIT SUPPORTS





















Image	Orbit #	Caddy #	B-Line #	Std. Pkg	
Cable & Conduit Supports					
	F6M24	6M24	BG-6-U-2-4	100	
	F6M58	6M58	BG-6-U-5-8	100	
	F6M912	6M912	BG-6-U-9-12	100	
	F812M24	812M24	BG-8-12-U-2-4	100	
	F812M58	812M58	BG-8-12-U-5-8	100	
	F812M912	812M912	BG-8-12-U-9-12	50	
	F16M24	16M24	BG-16-U-2-4	100	
	NEW F16M912	16M912	BG-16-U-9-12	50	
	F6MF	6MF	BG-6-B5	100	
	F812MF	812MF	BG-8-12-B5	100	
	F16MF	16MF	BG-16-B5	100	
	F20MF	20MF	BG-20-B5	50	
	NEW F350812M	350812M	BG-8-12-B1	100	
	STS-50	SCH8B	B1508S	100	
	STS-75	SCH12B	B1512S	100	
	STS-100	SCH16B	B1516S	100	
	STS-125	SCH20B	B1520S	50	
	STS-150	SCH24B	B1524S	50	
	STS-200	SCH32B	B1534S	50	
	STS-250	SCH48B	B1540S	50	
	STS-300	SCH56B	B1548S	50	
	STS-350	SCH64B	B1556S	50	
	STS-400	SCH72B	B1564S	50	
	ST-50	SK85I	BPC-8	100	
	ST-75	SK125I	BPC-12	100	
	ST-100	SK165I	BPC-16	100	
	ST-125	SK205I	BPC-20	100	
	ST-150	SK245I	BPC-24	50	
	ST-200	SK325I	BPC-32	50	
	ST-250	SK405I	BPC-40	50	
	ST-300	SK485I	BPC-48	25	
	ST-350	SK565I	BPC-56	25	
	ST-400	SK645I	BPC-64	25	
	<p>1/2" - 2" Break-apart design without Nut</p> <p>2-1/2" + Two-piece design with Nut</p>				

Image	Orbit #	Caddy #	B-Line #	Std. Pkg
Cable & Conduit Supports				
	CC	KX	BW4	100
	CC-8	K8	BW-8	100
	CC-12	K12	BW-12	100
	CC-16	K16	BW-16	100
	CC-20	K20	BW-20	100
	CCT	KBT	-	100
	NEW CWC1	PCS1	BX-8	100
	F6MATA	6MATA	BG-6-A6	100
	F812MATA	812MATA	BG-8-12-A6	100
	PH-50B	CD0B	BL1400	50
	PH-75B	CD1B	BL1410	50
	PH-100B	CD2B	BL1420	25
	PH-125B	CD3B	BL1430	50
	PH-150B	CD4B	BL1440	50
	PH-200B	CD5B	BL1450	20
	PH-250B	CD6B	BL1460	10
	PH-300B	CD7B	BL1470	10
	PH-350B	CD8B	BL1480	10
	PH-400B	CD9B	BL1490	5
	F8P	8P	BP-8	100
	F12P	12P	BP-12	100
	F16P	16P	BP-16	100
	F8PATS	8PATS	BP-8-A5	100
	F8P24	8P24	BP-8-U-2-4	100
	F8P58	8P58	BP-8-U-5-8	100
	F8P912	8P912	BP-8-U-9-12	50
	F12P24	12P24	BP-12-U-2-4	100
	F12P58	12P58	BP-12-U-5-8	100
	F12P912	12P912	BP-12-U-9-12	100
	F16P24	16P24	BP-16-U-2-4	100
	F16P58	16P58	BP-16-U-5-8	50
	F16P912	16P912	BP-16-U-9-12	50

CABLE & CONDUIT SUPPORTS

Image	Orbit #	Caddy #	B-Line #	Std. Pkg
Cable & Conduit Supports				
	F8P24SM	8P24SM	BP-8-E-2-4	100
	F8P58SM	8P58SM	BP-8-E-5-8	100
	F8P912SM	8P912SM	BP-8-E-9-12	100
	F12P24SM	12P24SM	BP-12-E-2-4	100
	F12P58SM	12P58SM	BP-12-E-5-8	100
	F12P912SM	12P912SM	BP-12-E-9-12	50
	F16P24SM	16P24SM	BP-16-E-2-5	100
	F16P58SM	16P58SM	BP-16-E-5-8	100
F16P912SM	16P912SM	BP-16-E-9-12	50	
	F4Z348P	4Z348P	BP-8-W2	100
	F6Z348P	6Z348P	BP-8-W6	100
	F4Z3412P	4Z3412P	BP-12-W2	100
	F6Z3412P	6Z3412P	BP-12-W6	100
	F4Z3416P	4Z3416P	BP-16-W2	100
	F6Z3416P	6Z3416P	BP-16-W6	100
 NEW	F123812M	123812M	BG-8-12-F13	100
	F4Z346M	4Z346M	-	100
	F4Z34812M	4Z34812M	BG-8-12-W2	100
	F6Z34812M	6Z34812M	BG-8-12-W6	100
	F4Z3416M	4Z3416M	BG-16-W2	100
	F6Z3416M	6Z3416M	BG-16-W6	100
NEW				
	SE1-75	EPS0075EG	B2301-3/4	100
	SE1-100	EPS0100EG	B2301-1	100
	SE1-125	EPS0125EG	B2301-1-1/4	100
	SE1-150	EPS0150EG	B2301-1-1/2	50
	SE1-200	EPS0200EG	B2301-2	50
		SU2-250	0080250EG	B2400-2-1/2
SU2-300		0080300EG	B2400-3	25
SU2-400		0080400EG	B2400-4	25

Image	Orbit #	Caddy #	B-Line #	Std. Pkg	
Cable & Conduit Supports					
	SR1-50	0070050EG	B2302-1/2	100	
	SR1-75	0070075EG	B2302-3/4	100	
	SR1-100	0070100EG	B2302-1	100	
	SR1-125	0070125EG	B2302-1-1/4	100	
	SR1-150	0070150EG	B2302-1-1/2	50	
	SR1-200	0070200EG	B2302-2	50	
		SR2-50	0080050EG	B2400-1/2	100
		SR2-75	0080075EG	B2400-3/4	100
SR2-100		0080100EG	B2400-1	100	
SR2-125		0080125EG	B2400-1-1/4	100	
SR2-150		0080150EG	B2400-1-1/2	50	
SR2-200		0080200EG	B2400-2	50	
Beam Clamps, Perlin Clips & Acoustical Clips					
	BC-25	BC200	BC442	50	
	BCSS	BC	BC1	100	
	FAF14	AF14	BF4	100	
	FAF144TI	AF144TI	BH4-F4	100	
	FAF146T	AF146T	BH5-F4	100	
	FAF146TI	AF146TI	BH6-F4	100	
 NEW	FATS4I	ATS4I	BA5-4T	100	
 NEW	FVF14	VF14	BF3	100	
	FM24	M24	BU-2-4	100	
	FM58	M58	BU-5-8	100	
	FM912	M912	BU-9-12	100	
	FM24S	M24S	BU-2-4-S	100	
	FM58S	M58S	BU-5-8-S	100	
	FM912S	M912S	BU-9-12-S	100	



T-BAR BOX HANGERS

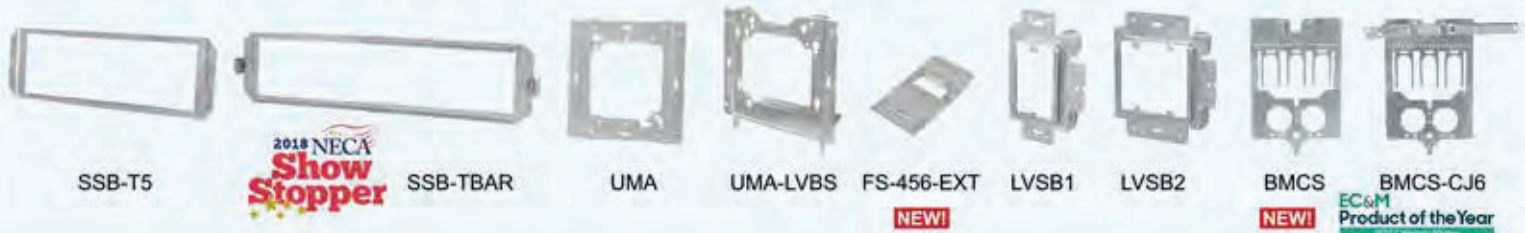

Image	Orbit #	Caddy #	B-Line #	Std. Pkg
T-Bar Hangers				
	BHT-1	512	BA12	50
	BHT-1A	512A	BA50A	50
	BHT-C	BHC	BB27	100

Image	Orbit #	Caddy #	B-Line #	Std. Pkg
T-Bar Hangers				
	BHT-1HD	512HD	BA50	25
	BHT-1HDEEP	512HDEEP	BA50D	25
	BH-3	520	BA20	50
	RAP-T	Recessed Light Adapter Plate for T-Bar installations		10

SIMPLE SUPPORT BRACKET FAMILY

The Most Versatile Solution for Junction Box Installation



READY-TO-INSTALL BOXES & BRACKETS

In Stock, Pre-Assembled Rough-In Products



DIRECT-TO-STUD

DATAKOM

CEILING T-BAR

MULTI-GANG

CEILING HARD LID

FIRE ALARM