

BOX ADAPTER FEATURES

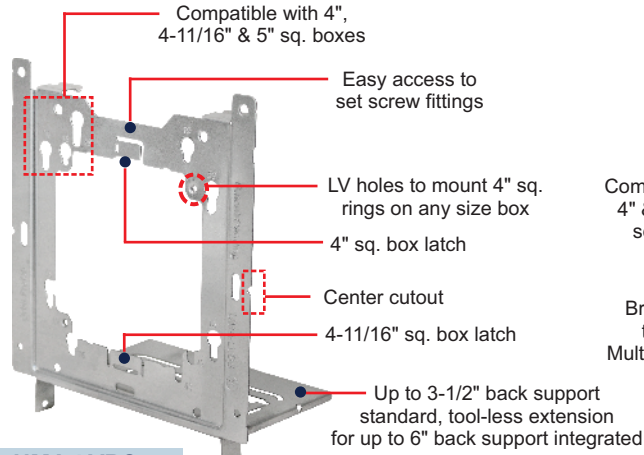

UMA-LVBS
*US-UMA-LVBS

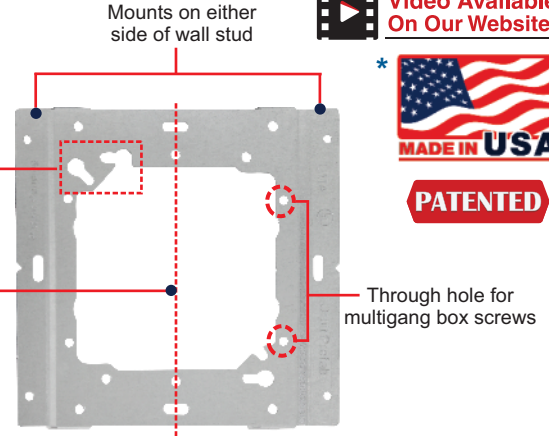

UMA

Video Available On Our Website!



PATENTED

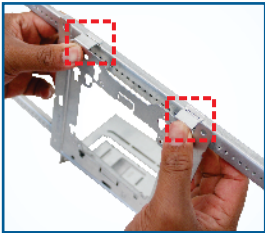

Adapters easily SNAP onto SSB Brackets

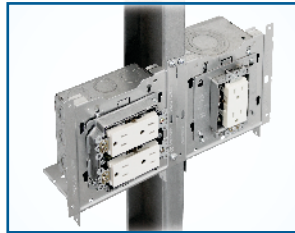

Pair 4" rings with any 4-11/16" or 5" sq. box with UMA-LVBS

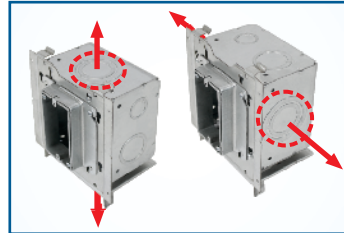

Turn any 4", 4-11/16" and 5" sq. box 90° with UMA-LVBS

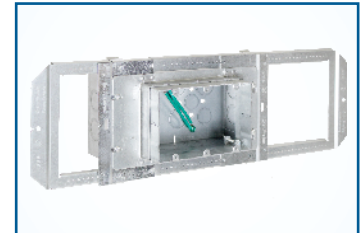

Break UMA in half to mount Multigang Boxes

SSB-T5 FEATURES

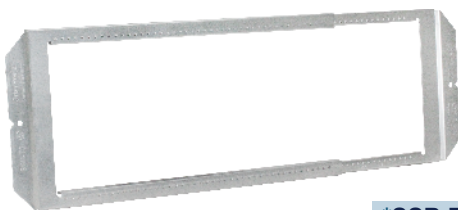

*SSB-T5

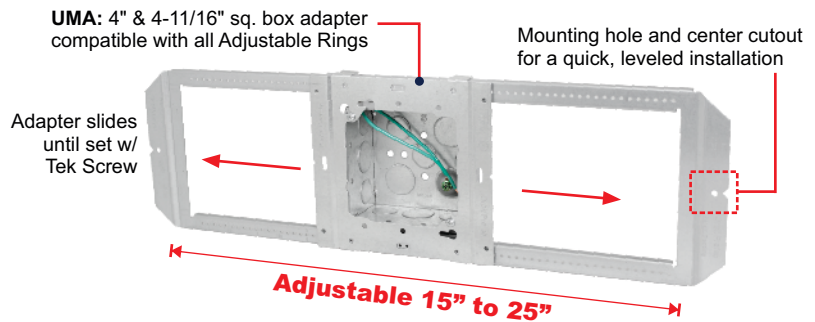

Order preassembled with box and 10" pigtail as SSB-4S-MKO, SSB-A4, SSB-5S-MKO or SSB-T5B-200 (pg. P7)

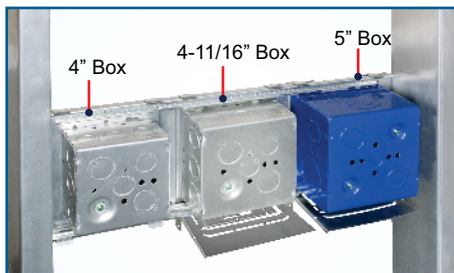

ANY SIZE J-BOX

SSB-T5 fits up to three 4", 4-11/16" or 5" boxes between 24" studs

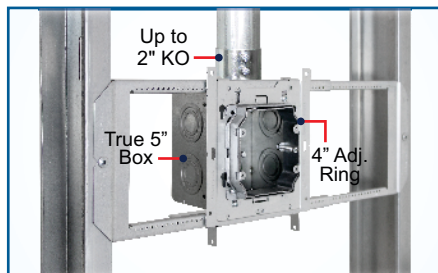

SSB-T5 INSTALLED

Use **5SLB-2MKO** (pg. P28) or **T5B's** (pg. P27) for 1-1/4" or larger conduit

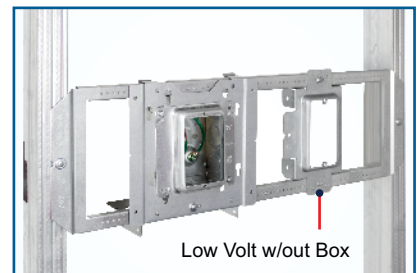

POWER + DATA

Use LVSB1 or 2 for Low Voltage applications that do not require a junction box